

**FLUKE®**

**Biomedical**

# **VT MOBILE**

Gas Flow Analyzer

## Operators Manual

February 2006

© 2006 Fluke Corporation. All rights reserved.

All product names are trademarks of their respective companies.

## **Warranty and Product Support**

Fluke Biomedical warrants this instrument against defects in materials and workmanship for one full year from the date of original purchase. During the warranty period, we will repair or, at our option, replace at no charge a product that proves to be defective, provided you return the product, shipping prepaid, to Fluke Biomedical. This warranty does not apply if the product has been damaged by accident or misuse or as the result of service or modification by other than Fluke Biomedical. **IN NO EVENT SHALL FLUKE BIOMEDICAL BE LIABLE FOR CONSEQUENTIAL DAMAGES.**

Only serialized products and their accessory items (those products and items bearing a distinct serial number tag) are covered under this one-year warranty. **PHYSICAL DAMAGE CAUSED BY MISUSE OR PHYSICAL ABUSE IS NOT COVERED UNDER THE WARRANTY.** Items such as cables and nonserialized modules are not covered under this warranty.

Recalibration of instruments is not covered under the warranty.

This warranty gives you specific legal rights, and you may also have other rights which vary from state to state, province to province, or country to country. This warranty is limited to repairing the instrument to Fluke Biomedical's specifications.

### ***Warranty Disclaimer***

Should you elect to have your instrument serviced and/or calibrated by someone other than Fluke Biomedical, please be advised that the original warranty covering your product becomes void when the tamper-resistant Quality Seal is removed or broken without proper factory authorization. We strongly recommend, therefore, that you send your instrument to Fluke Biomedical for factory service and calibration, especially during the original warranty period.

## Notices

---

### All Rights Reserved

© Copyright 2006, Fluke Biomedical. No part of this publication may be reproduced, transmitted, transcribed, stored in a retrieval system, or translated into any language without the written permission of Fluke Biomedical.

---

### Copyright Release

Fluke Biomedical agrees to a limited copyright release that allows you to reproduce manuals and other printed materials for use in service training programs and other technical publications. If you would like other reproductions or distributions, submit a written request to Fluke Biomedical.

---

### Unpacking and Inspection

Follow standard receiving practices upon receipt of the instrument. Check the shipping carton for damage. If damage is found, stop unpacking the instrument. Notify the carrier and ask for an agent to be present while the instrument is unpacked. There are no special unpacking instructions, but be careful not to damage the instrument when unpacking it. Inspect the instrument for physical damage such as bent or broken parts, dents, or scratches.

---

### Technical Support

For application support or answers to technical questions, either email [techservices@flukebiomedical.com](mailto:techservices@flukebiomedical.com) or call 1-800-648-7942 or 1-425-446-6945.

---

### Claims

Our routine method of shipment is via common carrier, FOB origin. Upon delivery, if physical damage is found, retain all packing materials in their original condition and contact the carrier immediately to file a claim. If the instrument is delivered in good physical condition but does not operate within specifications, or if there are any other problems not caused by shipping damage, please contact Fluke Biomedical or your local sales representative.

---

### Standard Terms and Conditions

#### **Refunds and Credits**

Please note that only serialized products and their accessory items (i.e., products and items bearing a distinct serial number tag) are eligible for partial refund and/or credit. Nonserialized parts and accessory items (e.g., cables, carrying cases, auxiliary modules, etc.) are not eligible for return or refund. Only products returned within 90 days from the date of original purchase are eligible for refund/credit. In order to receive a partial refund/credit of a product purchase price on a serialized product, the product must not have been damaged by the customer or by the carrier chosen by the customer to return the goods, and the product must be returned complete (meaning with all manuals, cables, accessories, etc.) and in "as new" and resalable condition. Products not returned within 90 days of purchase, or products which are not in "as new" and resalable condition, are not eligible for credit return and will be returned to the customer. The Return Procedure (see below) must be followed to assure prompt refund/credit.

#### **Restocking Charges**

Products returned within 30 days of original purchase are subject to a minimum restocking fee of 15 %. Products returned in excess of 30 days after purchase, but prior to 90 days, are subject to a minimum restocking fee of 20 %. Additional charges for damage and/or missing parts and accessories will be applied to all returns.

## Return Procedure

All items being returned (including all warranty-claim shipments) must be sent freight-prepaid to our factory location. When you return an instrument to Fluke Biomedical, we recommend using United Parcel Service, Federal Express, or Air Parcel Post. We also recommend that you insure your shipment for its actual replacement cost. Fluke Biomedical will not be responsible for lost shipments or instruments that are received in damaged condition due to improper packaging or handling.

Use the original carton and packaging material for shipment. If they are not available, we recommend the following guide for repackaging:

- Use a double-walled carton of sufficient strength for the weight being shipped.
- Use heavy paper or cardboard to protect all instrument surfaces. Use nonabrasive material around all projecting parts.
- Use at least four inches of tightly packed, industry-approved, shock-absorbent material around the instrument.

### Returns for partial refund/credit:

Every product returned for refund/credit must be accompanied by a Return Material Authorization (RMA) number, obtained from our Order Entry Group at 1-800-648-7952 or 1-425-446-6945.

### Repair and calibration:

To find the nearest service center, goto [www.flukebiomedical.com/service](http://www.flukebiomedical.com/service) or

In the U.S.A.:

Cleveland Calibration Lab  
Tel: 1-800-850-4606  
Email: [globalcal@flukebiomedical.com](mailto:globalcal@flukebiomedical.com)

Everett Calibration Lab  
Tel: 1-800-850-4606  
Email: [service.status@fluke.com](mailto:service.status@fluke.com)

In Europe, Middle East, and Africa:

Eindhoven Calibration Lab  
Tel: +31-402-675300  
Email: [ServiceDesk@fluke.com](mailto:ServiceDesk@fluke.com)

In Asia:

Everett Calibration Lab  
Tel: +425-446-6945  
Email: [service.international@fluke.com](mailto:service.international@fluke.com)

---

## Certification

This instrument was thoroughly tested and inspected. It was found to meet Fluke Biomedical's manufacturing specifications when it was shipped from the factory. Calibration measurements are traceable to the National Institute of Standards and Technology (NIST). Devices for which there are no NIST calibration standards are measured against in-house performance standards using accepted test procedures.

---

## WARNING

Unauthorized user modifications or application beyond the published specifications may result in electrical shock hazards or improper operation. Fluke Biomedical will not be responsible for any injuries sustained due to unauthorized equipment modifications.

---

## Restrictions and Liabilities













Information in this document is subject to change and does not represent a commitment by Fluke Biomedical. Changes made to the information in this document will be incorporated in new editions of the publication. No responsibility is assumed by Fluke Biomedical for the use or reliability of software or equipment that is not supplied by Fluke Biomedical, or by its affiliated dealers.

---

## Manufacturing Location

The VT MOBILE is manufactured in Everett, WA, U.S.A.

## Symbols

| Symbol  | Description  |
|---|--|
|    | See Operators Manual.  |
|    | Manufacturer's declaration of product compliance with applicable EU directives                           |
|    | CSA Listing mark   |
| <br>12V DC  | Battery Eliminator input   |
|    | Do not mix with solid waste stream. Dispose of using a qualified recycler or hazardous material handler. |
|  9V NEDA 1604A<br>6F22 006P  | 9-volt battery   |
|    | Flow Port  |
|    | Pressure Port  |
|    | Temperature and Relative Humidity Port   |
|    | Oxygen Sensor Port   |
|    | Battery Eliminator Port  |
| <b>IOIO</b>   | Miniature RS232 Port   |

## **⚠️⚠️ Warning. Read before using Analyzer.**

To avoid personal injury, follow these guidelines:

- Do not use the VT MOBILE in any manner not specified in the Operator's Manual. Otherwise, the protection provided by this product may be impaired.
- When measuring oxygen, always keep all components of test setup well away from open flame or other combustion-starting devices.
- Use in well-ventilated space. Be aware that a gas defined with VT for Windows software as 'User' may be unknown while using the VT MOBILE.
- For high pressure measurements, always turn off gas source before connection or disconnection of VT MOBILE. Be aware that there is no pressure indication on the VT MOBILE screen when VT for Windows software is in control.
- Always press power off on the VT MOBILE and unplug the battery eliminator before cleaning the outer surface.
- Inspect the product, if the instrument appears damaged or appears to operate in a manner not specified in the manual, DO NOT CONTINUE USE. Return the product for service.
- Avoid spilling liquids on the analyzer; fluid seepage into internal components creates corrosion and a potential shock hazard. Do not operate the instrument if internal components are exposed to fluid.
- Do not open this product. There are no user replaceable parts.

## **⚠️ Caution**

The VT MOBILE should be calibrated annually. Only qualified technical personnel should perform troubleshooting and service procedures on the VT MOBILE.

Do not expose the system to temperature extremes. Ambient operating temperatures should remain between 10 and 40 °C. System performance may be adversely affected if temperatures fluctuate above or below this range.

Clean only with a damp, lint-free cloth, using a mild detergent, and wipe down gently.

# Table of Contents

| Chapter  | Title  | Page       |
|----------|--|------------|
| <b>1</b> | <b>Introducing the VT MOBILE.....</b>          | <b>1-1</b> |
|          | Introduction.....                              | 1-1        |
|          | Operation, Storage, and Maintenance.....       | 1-1        |
|          | Features.....                                  | 1-2        |
|          | About This Manual.....                         | 1-2        |
| <b>2</b> | <b>Preparing for Operation.....</b>            | <b>2-1</b> |
|          | Unpacking the VT MOBILE.....                   | 2-1        |
|          | Powering Up.....                               | 2-3        |
|          | Using the Tilt Bail.....                       | 2-3        |
|          | Using the Keys.....                            | 2-4        |
|          | Selecting the Operating Mode.....              | 2-4        |
|          | Setting Up.....                                | 2-5        |
|          | Selecting the Gas Type.....                    | 2-5        |
|          | Gas Temperature and Relative Humidity.....     | 2-5        |
|          | Selecting the Correction Mode.....             | 2-5        |
|          | Setting the Breath Detect Threshold.....       | 2-6        |
|          | Setting Zero Warn ON or OFF.....               | 2-6        |
|          | Setting the Time.....                          | 2-7        |
|          | Setting the Date.....                          | 2-7        |
|          | Selecting the Date Format.....                 | 2-8        |
|          | Setting the Contrast.....                      | 2-8        |
|          | Checking Version and Serial Numbers.....       | 2-8        |
|          | Connecting the Analyzer.....                   | 2-8        |
|          | High-Flow Connection.....                      | 2-9        |
|          | Low-Flow Connection.....                       | 2-9        |
|          | High-Pressure Connection.....                  | 2-9        |
|          | Low-Pressure Connection.....                   | 2-9        |
|          | Ventilator Test Connections.....               | 2-10       |
| <b>3</b> | <b>Using the VT MOBILE.....</b>                | <b>3-1</b> |
|          | Understanding the Controls and Indicators..... | 3-1        |
|          | Screens.....                                   | 3-4        |
|          | Ventilator Parameters Screens.....             | 3-4        |

|          |   |            |
|----------|---|------------|
|          | Waveform Screens.....                                     | 3-6        |
|          | Other Measurements Screens .....                          | 3-9        |
|          | Special Functions Screens .....                           | 3-10       |
|          | Using Trend Test .....                                    | 3-12       |
|          | Making Measurements.....                                  | 3-14       |
|          | Working with Memory .....                                 | 3-14       |
|          | Printing .....  | 3-14       |
|          | Making a Measurement More Accurate .....                  | 3-14       |
|          | Warm-up and Zeroing .....                                 | 3-14       |
|          | Oxygen Sensor.....  | 3-16       |
|          | Verifying Oxygen Sensor Calibration .....                 | 3-16       |
|          | Calibrating the Oxygen Sensor.....                        | 3-16       |
|          | Using the Temperature and Relative Humidity Sensor .....  | 3-17       |
|          | Checking Barometric Pressure .....                        | 3-18       |
|          | Changing Barometric Pressure Units .....                  | 3-19       |
|          | Viewing Demo Data .....                                   | 3-19       |
|          | Accessing Help .....                                      | 3-19       |
| <b>4</b> | <b>Checking Ventilator Parameters .....</b>               | <b>4-1</b> |
|          | Introduction.....   | 4-1        |
|          | Checking Ventilator Parameters .....                      | 4-1        |
|          | Understanding the Parameters .....                        | 4-3        |
| <b>5</b> | <b>Measuring Pressure .....</b>                           | <b>5-1</b> |
|          | Introduction.....   | 5-1        |
|          | Measuring Low Pressure .....                              | 5-2        |
|          | Measuring High Pressure.....                              | 5-3        |
|          | Measuring Airway Pressure.....                            | 5-5        |
| <b>6</b> | <b>Measuring Flow and Volume.....</b>                     | <b>6-1</b> |
|          | Introduction.....   | 6-1        |
|          | Gas Settings.....   | 6-1        |
|          | Balance Gas Settings.....                                 | 6-1        |
|          | Correction Modes .....                                    | 6-2        |
|          | Flow Zeroing .....  | 6-2        |
|          | Measuring Low Flow.....                                   | 6-3        |
|          | Measuring High Flow .....                                 | 6-4        |
|          | Measuring Volume .....                                    | 6-5        |
| <b>7</b> | <b>Maintaining and Troubleshooting the VT MOBILE.....</b> | <b>7-1</b> |
|          | Introduction.....   | 7-1        |
|          | Calibration and Service.....                              | 7-1        |
|          | Battery.....  | 7-1        |
|          | Cleaning .....  | 7-2        |
|          | Verifying Oxygen Sensor Calibration .....                 | 7-2        |
|          | Replacing the Oxygen Sensor.....                          | 7-3        |
|          | Calibrating the Oxygen Sensor .....                       | 7-3        |
|          | Troubleshooting .....                                     | 7-4        |
|          | <b>Appendices</b>   |            |
|          | A VT for Windows.....                                     | A-1        |
|          | B Specifications .....                                    | B-1        |



# ***List of Tables***

| <b>Table</b> | <b>Title</b>                       | <b>Page</b> |
|--------------|------------------------------------|-------------|
| 1-1.         | VT MOBILE Versions .....           | 1-1         |
| 2-1.         | Standard Accessories .....         | 2-2         |
| 2-2.         | Optional Accessories.....          | 2-2         |
| 2-3.         | Gas Types.....                     | 2-5         |
| 2-4.         | Correction Modes.....              | 2-6         |
| 3-1.         | Controls and Indicators .....      | 3-2         |
| 3-2.         | Ventilator Parameters .....        | 3-4         |
| 4-1.         | Ventilator Parameters .....        | 4-3         |
| 7-1.         | Troubleshooting the Analyzer ..... | 7-4         |



# List of Figures

| Figure | Title  | Page |
|--------|--|------|
| 2-1.   | Key Available Accessories.....                       | 2-3  |
| 2-2.   | VT MOBILE Tilt Bail.....                             | 2-4  |
| 2-3.   | Low-Pressure/High-Flow/Low-Flow Connection.....      | 2-8  |
| 2-4.   | High-Pressure Connection.....                        | 2-9  |
| 2-5.   | Ventilator Test Connections.....                     | 2-10 |
| 3-1.   | Controls and Indicators .....                        | 3-1  |
| 3-2.   | Flow Sensors and Pressure Adapters Disconnected..... | 3-15 |
| 3-3.   | Flow Sensors and Pressure Adapters Connected .....   | 3-15 |
| 3-4.   | Oxygen Sensor Calibration .....                      | 3-17 |
| 3-5.   | Measuring Temperature and Relative Humidity .....    | 3-18 |
| 4-1.   | Ventilator Connections.....                          | 4-2  |
| 4-2.   | Accessing Calculated Parameters.....                 | 4-4  |
| 4-3.   | Accessing Other Parameters.....                      | 4-4  |
| 5-1.   | Measuring Low Pressure.....                          | 5-2  |
| 5-2.   | Accessing Low-Pressure Measurements .....            | 5-3  |
| 5-3.   | Measuring High Pressure .....                        | 5-4  |
| 5-4.   | Accessing High-Pressure Measurements .....           | 5-4  |
| 5-5.   | Accessing Airway Pressure Measurements.....          | 5-5  |
| 6-1.   | Measuring Low Flow .....                             | 6-3  |
| 6-2.   | Accessing Low-Flow Measurements .....                | 6-4  |
| 6-3.   | Measuring High Flow .....                            | 6-5  |
| 6-4.   | Accessing High-Flow Measurements.....                | 6-5  |
| 7-1.   | Changing the Battery.....                            | 7-2  |
| 7-2.   | Oxygen Sensor Calibration .....                      | 7-3  |



# Chapter 1

## Introducing the VT MOBILE

### Introduction

This Operators Manual provides complete operating instructions for the Fluke Biomedical VT MOBILE Gas Flow Analyzer (hereafter referred to as the Analyzer.) Seven language options support the available factory-set versions of the Analyzer. The overlay language identifies these.

The Analyzer is a general-purpose, portable gas flow analyzer with special modes designed specifically for testing mechanical patient ventilators. The Analyzer measures bi-directional flow in both high and low ranges as well as high- and low-pressure ranges. The Analyzer is not for use in the patient environment. Table 1-1 identifies Analyzer language versions.

The Analyzer measures the basic signals of pressure, flow, and oxygen. From these basic signals, the Analyzer computes other parameters. The Analyzer obtains volume from the integration, or summation, of the flow signal over a period of time.

**Table 1-1. VT MOBILE Versions**

| Version        | Language Overlay |
|----------------|------------------|
| VT MOBILE US   | English          |
| VT MOBILE FRA  | French           |
| VT MOBILE DEU  | German           |
| VT MOBILE ITAL | Italian          |
| VT MOBILE SPAN | Spanish          |
| VT MOBILE JPN  | Japanese         |
| VT MOBILE CHI  | Chinese          |

### Operation, Storage, and Maintenance

Operate the Analyzer in a dry area within temperature limits of 10 °C to 40 °C. The maximum operating relative humidity at temperatures up to 31 °C is 80 % non-condensing, decreasing linearly to 50 % non-condensing at 40 °C.

Store the Analyzer at a temperature of -25 °C to 50 °C and at a non-condensing relative humidity of 0 to 95 %.

The battery is the only user-serviceable part in the Analyzer. For safety reasons, only an experienced technician should perform maintenance requiring other internal access.

## **Features**

Features include:

- **Percent Oxygen Measurement.** An oxygen sensor measures the oxygen percent of the gas in series with the high- or low-flow channel of the Analyzer. Maxtec oxygen sensor distributed by Fluke Biomedical.
- **Breath Parameters.** The Analyzer measures 16 parameters on each detected breath. These parameters include tidal volume, minute volume, inspiratory and expiratory pressures, etc.
- **Selectable Units.** The Analyzer allows you to select the desired units for each of the measured signals. For example, pressures can be displayed in mmHg, kPa, bar, mbar, atm, inH<sub>2</sub>O, inHg, cmH<sub>2</sub>O or mmHg.
- **Gas Type.** Select the gas type from a pre-defined list, or, using the VT for Windows software, specify a user-defined gas.
- **Trend Testing.** The Analyzer provides an automated test to see if a predetermined parameter deviates from limits you set.
- **Evaluations/Troubleshooting.** Use the Analyzer for pre-purchase evaluations of ventilators, incoming and routine performance verification, and troubleshooting clinical problems, as well as teaching principles of mechanical ventilation.
- **Computer Control, Data Logging, and Printing.** A miniature RS232 serial port allows connection to a personal computer for external Analyzer control, data logging of test results, and printing. The Analyzer is compatible with Fluke Biomedical's VT for Windows PC software (version 2.01.00 or higher.)
- **Lung Simulator.** The Analyzer operates with or without a test lung attached. Use the optional Fluke Biomedical ACCU LUNG as a test lung with integrated airway restrictors that assist you in evaluating intermittent errors.

## **About This Manual**

This manual provides a complete description of the Analyzer and its applications. The manual contains information for beginners as well as experts in mechanical ventilator evaluation and separate measurement of pressure, flow, and volume.

Chapters are as follows:

- **Chapter 1: Introducing the VT MOBILE.** An introduction to the Analyzer
- **Chapter 2: Preparing for Operation.** Unpacking and setting up the Analyzer
- **Chapter 3: Using the VT MOBILE.** How to use the keys and interpret the screens
- **Chapter 4: Checking Ventilator Parameters.** How to access and interpret the 16 ventilator parameters
- **Chapter 5: Measuring Pressure.** How to measure high and low pressure
- **Chapter 6: Measuring Flow and Volume.** How to measure high and low flow and derive volume
- **Chapter 7: Maintaining and Troubleshooting the VT MOBILE.** How to perform maintenance and routine troubleshooting
- **Appendix A: VT for Windows PC Software**
- **Appendix B: Specifications**

## **Chapter 2**

# **Preparing for Operation**

### **Unpacking the VT MOBILE**

Before unpacking the Analyzer, visually inspect the shipping box for damage. If no damage is evident, unpack the Analyzer and its accessories from the shipping carton. Table 2-1 lists the standard accessories included in the box. Save the foam inserts and shipping box. You must use the original packing materials when shipping the Analyzer for service or re-calibration. If the original shipping carton and packing materials are not available, call a Fluke Biomedical service representative for assistance.

Identify accessories for your Analyzer with the aid of Tables 2-1, 2-2 and Figure 2-1. Check for missing parts. Carefully inspect the unit for damage such as cracks, dents, or bent parts. If items are missing or any physical damage is apparent, call Fluke Biomedical for assistance. For information on ways to contact Fluke Biomedical, see the section in this manual called "Support." Also, notify the carrier if the damage appears to be the result of a shipping mishap.

**Table 2-1. Standard Accessories**

| <b>Item</b>   | <b>Part Number</b> |
|---|--------------------|
| Accessory Kit   | 2548405            |
| High-Flow Sensor  | 2438334            |
| High-Pressure Adapter (Luer to Male Nut/Nipple D.I.S.S. Oxygen)   | 2548303            |
| Low-Pressure Adapter  | 2454175            |
| Oxygen Sensor   | 2448801            |
| Oxygen Sensor Cable 6'  | 2448051            |
| 'T', 15 mm ID, 22 mm ID, 15 mm ID end   | 2457028            |
| VT MOBILE RS232 Cable, 6'   | 2075257            |
| 9 VDC Battery (Alkaline)  | 614487             |
| Battery Eliminator  | 2547455            |
| Soft Carrying Case  | 2523995            |
| Information Packet: Getting Started Manual; Quick Reference Card; CD with Quick Reference Card, Getting Started Manual, Operators Manual, VT for Windows (V2.01.00 +) | 2544926            |

**Table 2-2. Optional Accessories**

| <b>Item</b>   | <b>Part No.</b> |
|---|-----------------|
| Low-Flow Sensor   | 2438352         |
| High-Pressure Adapter (Luer to Female D.I.S.S. Oxygen)          | 2548315         |
| Temperature and RH Sensor Assembly                              | 2541622         |
| Serial Communications Cable (RS232) DB9F to miniature RS232, 6' | 2075257         |
| Power Adapter, Universal (USA and International)                | 2118212         |
| ACCU LUNG Portable, Precision Test Lung                         | 2387318         |



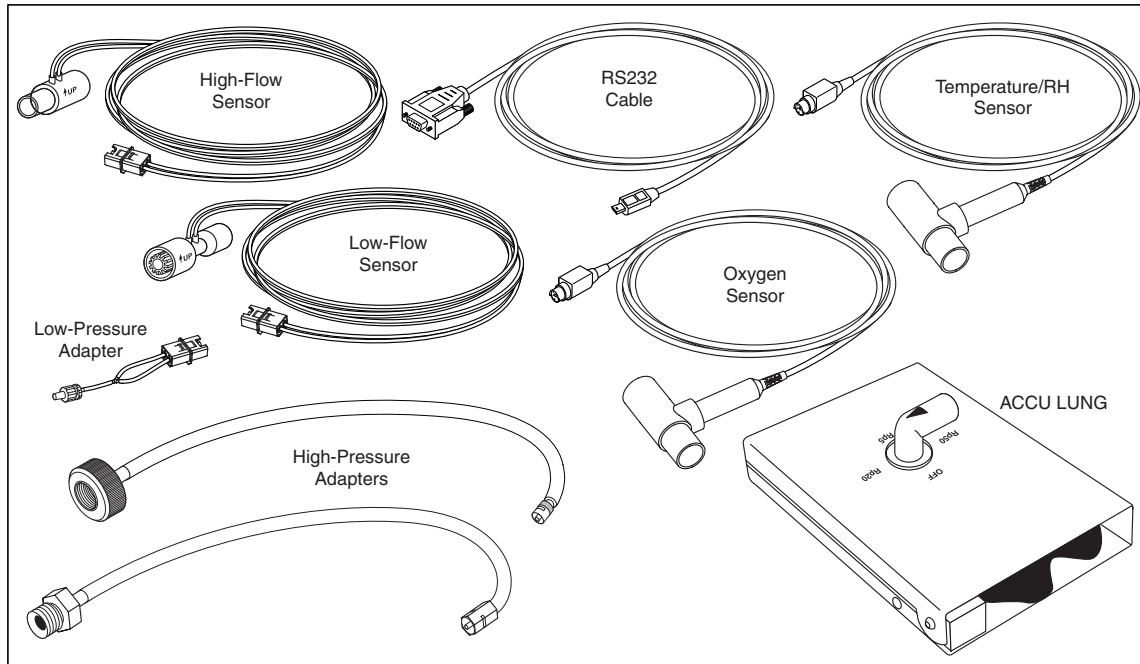

ede03f.eps

Figure 2-1. Key Available Accessories

## Powering Up

1. Press the Power key (⏻) to power on the Analyzer. The Analyzer displays the power up screen for several seconds.
2. The Analyzer then prompts you for the zeroing procedure. Place the Analyzer on a flat surface, and, if necessary, disconnect flow and pressure sensors.

### ⚠ Warning

**Make sure pressure is set to zero before disconnecting the High-Pressure Adapter. Exposure to high pressure could cause personal injury.**

3. Press **F2** (Ok). The Analyzer now performs the zeroing procedure. After several seconds, the Tidal Volume screen appears and the Analyzer is ready for use. If you have pressed **ZERO SENSORS** to initiate the zero procedure, the Analyzer returns to the previous screen displayed.

### Note

*If the Analyzer encounters a power problem (such as a backwards battery), thermal overload devices interrupt normal operation. Repair the problem, wait several seconds, and resume normal operation.*

## Using the Tilt Bail

As shown in Figure 2-2, you can use the Analyzer in flat or elevated positions. Do not use the Analyzer by hand or during transport.

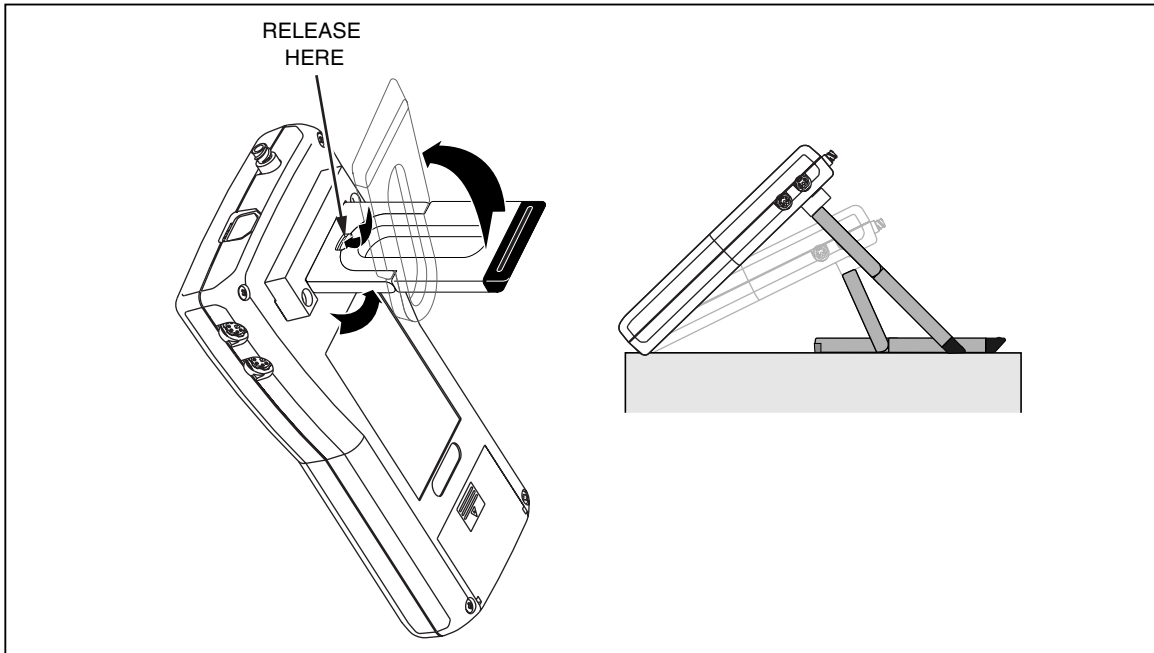







Figure 2-2. VT MOBILE Tilt Bail

edg21f.eps

## Using the Keys

Press each key firmly; the Analyzer responds to a recognized key press with a beep. Generally, you can exit one function by selecting another function. Press the  and  navigation keys to cycle through multiple functions accessed from one key. Relevant functions for the two softkeys ( and ) appear in the display immediately above these keys. When text entry is necessary, quickly press a key to cycle through the characters it accesses. Pause to accept the present character and move to the next entry. Think of text entry as text messaging, as you would encounter on a cell phone.

### Note

*If the Zero warning screen appears at any time, follow on-screen directions and then press ; the interrupted function will continue automatically after the zeroing procedure.*

## Selecting the Operating Mode

Local Mode is the default setting upon powering up the Analyzer. In Local Mode, select functions by pressing keys on the front panel.

To change modes from Local to Remote, first connect the serial cable to both the PC and the miniature RS-232 serial port on the Analyzer. Launch VT for Windows software (version 2.01.00 or higher) to activate Remote Mode.

If VT for Windows has remote control, the following appears on the Analyzer display screen:

No Graphics Available, While Communications Are Active



Normal local key presses have no effect. Press  (Cancel) to regain local control.

## Setting Up

Press  to access Analyzer settings. (Press  to return to the measurement screen.)

### Selecting the Gas Type

Ensure that you have selected the gas or gas mixture you will be using, as the gas density will be different for each gas type and mixture. The Analyzer uses this information to improve the accuracy of the flow calculations. Failure to enter the correct value will cause the flow and volume calculations to be in error.

Select the gas type by pressing  → **ENTER** → **ENTER** →  or  → **ENTER**. Available selections are: Air, O<sub>2</sub>, Heliox, CO<sub>2</sub>, N<sub>2</sub>, N<sub>2</sub>O, N<sub>2</sub>O/O<sub>2</sub> (N<sub>2</sub>O balance O<sub>2</sub>), He/O<sub>2</sub> (He balance O<sub>2</sub>), N<sub>2</sub>/O<sub>2</sub> (N<sub>2</sub> balance O<sub>2</sub>), and User. Refer to Table 2-3 for descriptions of gas types. Only the VT for Windows software can identify a ‘User’ gas.

**Table 2-3. Gas Types**

| Gas                                 | Description   |
|-------------------------------------|---|
| Air                                 | Standard room air   |
| O <sub>2</sub>                      | 100% Oxygen   |
| Heliox                              | 30% Oxygen and 70% Helium blend   |
| CO <sub>2</sub>                     | 100% Carbon Dioxide   |
| N <sub>2</sub>                      | 100% Nitrogen   |
| N <sub>2</sub> O                    | 100% Nitrous Oxide  |
| N <sub>2</sub> O bal O <sub>2</sub> | Measured Oxygen balance Nitrous Oxide   |
| He bal O <sub>2</sub>               | Measured Oxygen balance Helium  |
| N <sub>2</sub> bal O <sub>2</sub>   | Measured Oxygen balance Nitrogen  |
| User                                | User selects custom gas mixture. This option requires the VT for Windows PC software. |



### Gas Temperature and Relative Humidity

These parameters are not really settings, but are available when the optional Temperature and Relative Humidity Sensor is connected. The Analyzer measures the gas flowing through the sensor and uses this information to improve the accuracy of the flow measurements. All temperatures are in degrees Celsius.

### Selecting the Correction Mode

This setting calculates the flow volume of the air flowing through the high or low-flow ports. Ensure that the correction mode setting matches the one used by the ventilator or anesthesia machine manufacturer for their display of flow and volume measurements. If the correction mode is unknown, select “ATP” (Ambient Temperature and Pressure). Refer to Table 2-4 for descriptions of the correction modes.

The Analyzer can operate with a correction mode of ATP, STPD<sub>21</sub>, BTPS, or STPD<sub>0</sub>. Select the mode as follows:

1. Press  → **ENTER** →  (to ‘Corr Mode’)
2. Press **ENTER** →  (to select mode)
3. Press **ENTER** to activate your selection.

**Table 2-4. Correction Modes**





| Mode               | Name   | Description  |
|--------------------|--|--|
| ATP                | Ambient Temperature and Pressure                         | The Analyzer corrects the flow rate (and therefore, volume) such that the reported flow equals the flow if the gas temperature and pressure are at ambient (room) temperature and pressure.  |
| BTPS               | Body Temperature and Pressure Saturated with water vapor | The Analyzer corrects the flow rate (and therefore, volume) such that the reported flow equals the flow if the gas temperature and pressure were changed to body conditions (37 °C and ambient pressure). Further, the Analyzer compensates the flow to add the amount of water vapor as if to make the gas fully saturated (i.e. 100% relative humidity). In this correction, the Analyzer uses the relative humidity reading to determine the amount of water vapor that would need to be added. |
| STPD <sub>0</sub>  | Standard Temperature and Pressure Dry, 0 °C              | The Analyzer corrects the flow rate (and therefore, volume) such that the reported flow equals the flow if the gas temperature and pressure were changed to standard conditions (0 °C and 760 mmHg). Further, the Analyzer compensates the flow to subtract the amount of water vapor as if the gas was dry (i.e. 0% relative humidity). In this correction, the Analyzer uses the relative humidity reading to determine the amount of water vapor that would need to be subtracted.              |
| STPD <sub>21</sub> | Standard Temperature and Pressure Dry, 21 °C             | The Analyzer corrects the flow rate (and therefore, volume) such that the reported flow equals the flow if the gas temperature and pressure were changed to standard conditions (21°C and 760 mmHg). Further, the Analyzer compensates the flow to subtract the amount of water vapor as if the gas was dry (i.e. 0% relative humidity). In this correction, the Analyzer uses the relative humidity reading to determine the amount of water vapor that would need to be subtracted.              |

### Setting the Breath Detect Threshold

The Analyzer breath detection algorithm uses a flow rate threshold that the inspiratory flow must cross to trigger a change in the breath phase. Higher flow rate thresholds yield less sensitive breath detection. Lower thresholds yield more sensitive breath detection.

The default setting of 2.00 lpm is usually appropriate for the ventilators and anesthesia machines being tested. This setting tells the Analyzer how to divide the delivered flow into breaths. If necessary, adjust the Breath Detect Threshold up or down until the breath rate reported on the Analyzer Timing display matches the ventilator breath rate.

Set the threshold as follows:

1. Press  → **ENTER** →  (to 'BD Thresh').
2. Press **ENTER** →  or  (to change threshold in increments of 0.25). You can also use text entry to enter a new value directly.
3. Press **ENTER** to activate your selection.

### Setting Zero Warn ON or OFF



You need to "zero" (or calibrate) the pressure and differential pressure (flow) sensors in the Analyzer to a zero reference. This "zero" reminder function can be set to occur automatically at pre-determined intervals or only when you request the function by pressing . The Zero Warn is helpful in reminding you to stop and zero the transducers from time-to-time during operation. This is especially important during the 40-minute warm-up to full stability. The Analyzer does not calculate breath parameters for any breath in which a zero occurs. For this reason, it may be desirable to turn off automatic zeroing for a short while during a critical test.

The Analyzer Zero Warn is set to ON at the factory to remind you to zero out any offset in the Flow measurements. The Zero Warn screen reminds you at power on, after the first five minutes, and then after each 30-minute period. After the power-on zero warning, you can choose to Zero or Cancel when the reminder appears; either action returns the Analyzer to the same function.

**⚠ Caution**

**Setting Zero Warn to OFF may result in introduction of offset into the Flow and Volume measurements and cause errors in the assessment of those measurements against the medical device under test specification. Fluke Biomedical strongly recommends that you leave Zero Warn ON.**





Turn this warning on or off using the following procedure:

1. Press  → **ENTER** →  (to 'Zero Warn').
2. Press **ENTER** →  (to select ON or OFF).
3. Press **ENTER** to activate your selection.

**Setting the Time**





You can set hours and minutes. Enter the time in the HHMM or HMM format, where HH or H is the hours in 12-hour format and MM is the minutes (00 through 59).

To set the time, follow these steps:

1. Press  →  → **ENTER** →  → **ENTER** to access the time setting screen.
2. Enter the hour (HH or H) with the text entry keys.
3. Press .
3. Enter the minutes (MM) with the text entry keys.
4. Press  to select P (PM) or A (AM).
5. Press **ENTER**.

**Setting the Date**

To set the date, follow these steps:

1. Press  →  → **ENTER** → **ENTER** to access the date setting screen.
2. Enter the month (MM) or day (DD), depending on the date format, with the text entry keys.
3. Press .
4. Enter the day (DD) or month (MM) with the text entry keys.
5. Press .
6. Enter the year (YYYY) with the text entry keys.
7. Press **ENTER**.

The Analyzer displays the date with the following information:

- MM is the number between 1 and 12 corresponding to the month.
- DD is the number between 1 and 31 corresponding to the day of the month.
- YYYY is the year.

### Selecting the Date Format

The Analyzer uses either of the following date formats:

- M/D/Y
- D/M/Y

To change the format, follow these steps:

1. Press **Menu** → **Down Arrow** → **ENTER** → **Down Arrow** → **Down Arrow** → **ENTER**
2. Press **Left Arrow** or **Right Arrow** to select 'M/D/Y' or 'D/M/Y'.
3. Press **ENTER** to activate your choice.
4. Press **F2** to return to the active display screen.

### Setting the Contrast

Use the following procedure to change the screen contrast:

1. Press **Menu** → **Down Arrow** → **ENTER**.
2. Highlight Contrast by scrolling down with **Down Arrow**.
3. Press **ENTER** and adjust the contrast in either of the following ways:
  - Press **Left Arrow** or **Right Arrow** to increment or decrement the contrast in steps of 10.
  - Enter any contrast value directly using the text entry keys.

### Checking Version and Serial Numbers

Press **Menu** → **Down Arrow** → **Down Arrow** → **ENTER** to check the version and serial numbers.

### Connecting the Analyzer

Connect the Analyzer for flow and pressure measurements as shown in Figures 2-3 and 2-4.

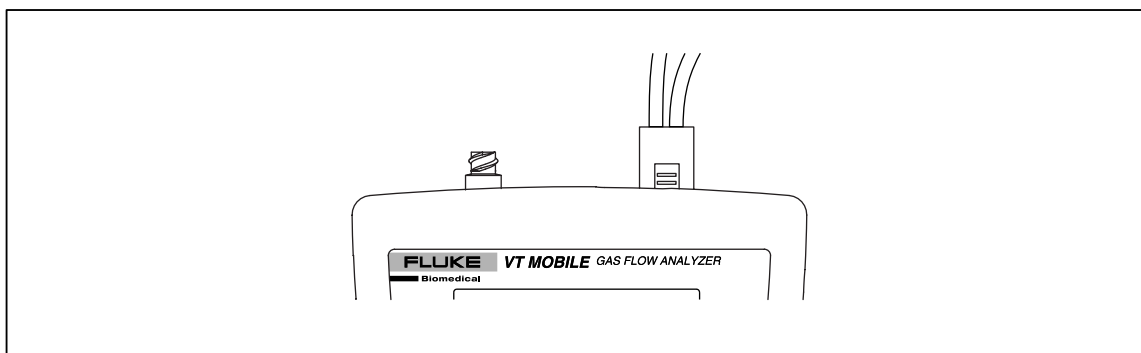
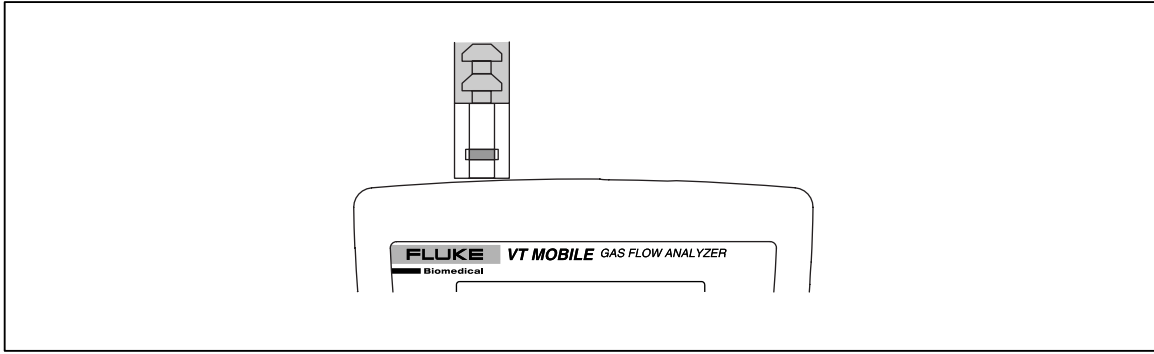

Figure 2-3. Low-Pressure/High-Flow/Low-Flow Connection

edg23f.eps



edg22f.eps

Figure 2-4. High-Pressure Connection

### High-Flow Connection

The High-Flow Sensor connects to the flow/low-pressure port on the top of the Analyzer. Connect the High-Flow Sensor in line using adapters from the Accessory Kit.

#### ⚠ Caution

**Do not exceed a flow of 200 lpm through the high-flow port. Damage to the Analyzer could otherwise result.**

**Measure only dry gases using the high-flow port. Do not use this port to measure exhaled or artificially humidified gases.**

### Low-Flow Connection

The Low-Flow Sensor connects to the flow/low-pressure port on the top of the Analyzer. Connect the Low-Flow Sensor in line using adapters from the Accessory Kit.

#### ⚠ Caution

**Do not exceed a flow of 35 lpm through the low-flow port. Damage to the Analyzer could otherwise result.**

**Measure only dry gases using the low-flow port. Do not use this port to measure exhaled or artificially humidified gases.**

### High-Pressure Connection

The High-Pressure Adapter connects to the high-pressure port on the top of the Analyzer. The connector mates to standard oxygen DISS fittings as used on oxygen supply hoses. Connectors are available with male or female fittings. Do not apply fluid to the high-pressure port.

#### ⚠ Caution

**Do not exceed a pressure of 125 psi at the high-pressure port. Damage to the Analyzer could otherwise result.**

### Low-Pressure Connection

The Low-Pressure Adapter connects to the flow/low-pressure port on the top of the Analyzer. Do not apply fluid to the low-pressure port.

**⚠ Caution**

**Do not exceed a pressure of 5 psi at the low-pressure port.  
Damage to the Analyzer could otherwise result.**

**Ventilator Test Connections**

Ventilator testing involves multiple connections as shown in Figure 2-5.

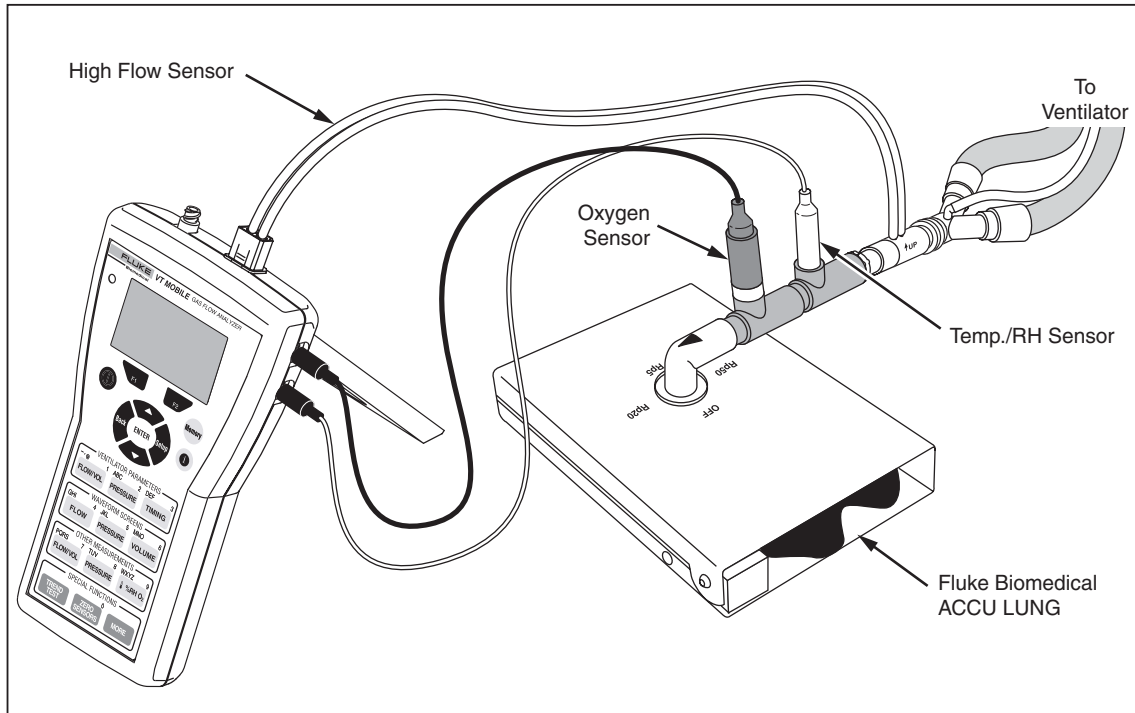

**Figure 2-5. Ventilator Test Connections**

ede06f.eps



# Chapter 3

## Using the VT MOBILE

### Understanding the Controls and Indicators

Figure 3-1 and Table 3-1 describe the controls and indicators.

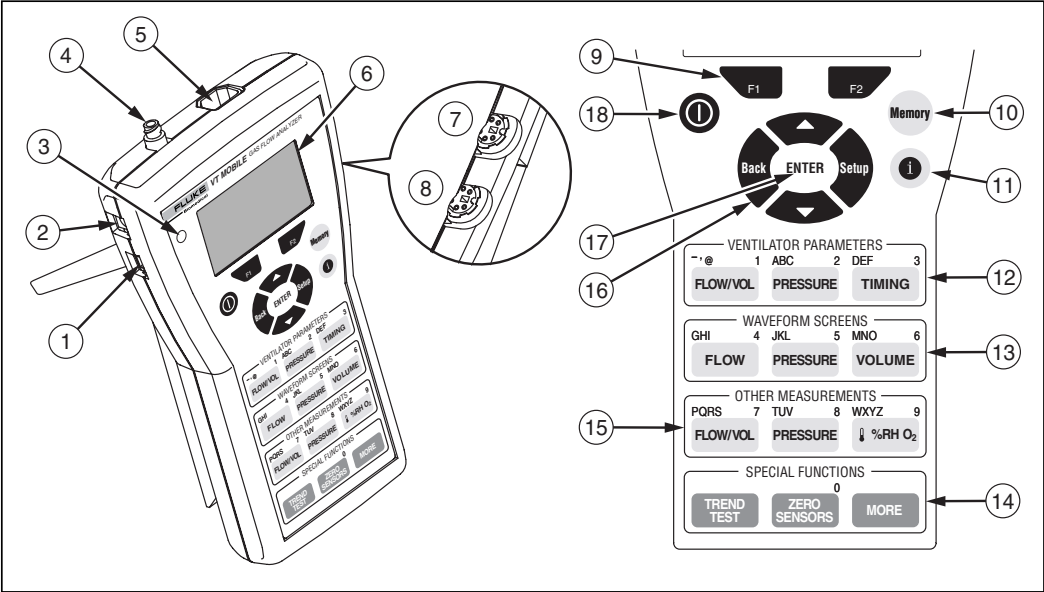

Figure 3-1. Controls and Indicators

ede01f.eps

**Table 3-1. Controls and Indicators**





















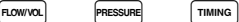





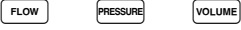







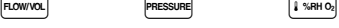





| No. | Name  | Description/Use  |
|-----|---|--|
| ①   | Miniature RS-232 Serial Port  | Connect the RS-232 cable here (for use with VT for Windows software.)  |
| ②   | Battery Eliminator Connector  | Connect the battery eliminator here. Use the battery eliminator whenever possible.   |
| ③   | Battery Eliminator Indicator  | Glows green when the battery eliminator is supplying power to the Analyzer. Note that this power source cannot recharge the battery.   |
| ④   | High-Pressure Connector   | Connect the High-Pressure Adapter here. The Analyzer makes high-pressure measurements from -2 to 100 psi.  |
| ⑤   | Flow and Low-Pressure Connector   | Insert one of three coded modular connectors here; the Analyzer automatically detects the connector type. The Analyzer use the High-Flow Sensor to measure up to $\pm 150$ lpm, the Low-Flow Sensor to measure up to $\pm 25$ lpm, or the Low-Pressure Adapter to measure from -20 to 120 cmH <sub>2</sub> O.  |
| ⑥   | Display Screen  | Shows measurement parameters and statistics (Min, Avg, and Max), waveforms, and setup selections. English only.  |
| ⑦   | Oxygen Sensor Connector   | Connect the Oxygen Sensor here. The Analyzer makes O <sub>2</sub> measurements from 0 to 100%.   |
| ⑧   | Temperature, RH Sensor Connector  | Connect the optional Temperature and Relative Humidity Sensor here.  |
| ⑨   | Softkeys<br>                   | Use  and  to access selections identified on the screen immediately above these keys.  |
| ⑩   | Memory Key<br>                 | Press  to save, view, or delete memory files. A memory file contains data to reconstruct all aspects of a stored screen (reading, statistics, waveform, parameters, etc.)   |
| ⑪   | Help Key<br>                   | Press  to access context-sensitive help. If necessary, press  or  to scroll through additional text. Press  to return to the previous screen.  |
| ⑫   | Ventilator Parameters Keys<br> | Press  ,  , or  to display ventilator measurement parameters. When text entry is required, press  successively to cycle through 1 → - → @. Press  to cycle through A → B → C → 2, and press  to cycle through D → E → F → 3. |

Table 3-1. Controls and Indicators (cont.)

| No. | Name   | Description/Use   |
|-----|--|---|
| ⑬   | Waveform Screens Keys<br>   | Press  ,  , or  to display specific waveforms.<br>For any waveform, press  (Rescale) to optimize the display or press  (Units) to select new units of measurement. When text entry is required, press  successively to cycle through G → H → I → 4. Press  to cycle through J → K → L → 5, and press  to cycle through M → N → O → 6. |
| ⑭   | Other Measurements Keys<br> | Press  to access direct readings and statistics of flow and volume. Press  for readings and statistics of high or low pressure. Repeated presses of  yield readings of O2 %, temperature, and relative humidity. When text entry is required, press  successively to cycle through P → Q → R → S → 7. Press  to cycle through T → U → V → 8, and press  to cycle through W → X → Y → Z → 9.   |
| ⑮   | Special Functions Keys<br>  | Press  to start new or review old trending data. Press  at any time to initiate the zeroing procedure or, when keypad entry is required, to enter 0. Press  to access barometric pressure and battery readings.  |
| ⑯   | Navigation Keys<br>         | Press  to exit specific screens (Setup, Memory, Help, More, etc.)<br>Press  or  to cycle through specific screen selections (Setup, Memory, More, etc.) or to scroll through help text. Press  to access system settings (Gas Type, Correction Mode, Breath Detect Threshold, Zero Warning, Date, Time, and version numbers.)   |
| ⑰   | Enter Key<br><b>ENTER</b>  | Press <b>ENTER</b> to activate a menu selection.  |
| ⑱   | Power Key<br>             | Press and briefly hold this key to power on or power off the Analyzer.  |

## Screens

### Ventilator Parameters Screens

The Analyzer calculates 16 parameters for every breath. You can display all parameters individually or most parameters in groups of four. Parameters update following every breath. Units of measure for breath parameters are fixed. Table 3-2 shows parameters and groupings, along with abbreviations and units of measurement.

**Table 3-2. Ventilator Parameters**

| <b>Parameter</b>                             | <b>Units</b>       |
|--|--------------------|
| Inspiratory and Expiratory Tidal Volume (VT) | ml                 |
| Expiratory Minute Volume (MV)                | lpm                |
| Peak Inspiratory Flow (PIF)                  | lpm                |
| Peak Expiratory Flow (PEF)                   | lpm                |
| Peak Inspiratory Pressure (PIP)              | cmH <sub>2</sub> O |
| Positive-End Expiratory Pressure (PEEP)      | cmH <sub>2</sub> O |
| Mean Airway Pressure (MAP)                   | cmH <sub>2</sub> O |
| Inspiratory Pause Pressure (IPP)             | cmH <sub>2</sub> O |
| Breath Rate (Rate)                           | bpm                |
| Inspiratory Time (Ti)                        | s                  |
| Expiratory Time (Te)                         | s                  |
| Inspiratory, Expiratory Time (I:E) Ratio     | s:s                |
| Oxygen Concentration                         | % O <sub>2</sub>   |
| Temperature (optional)                       | °C (selectable)    |
| Relative Humidity (optional)                 | % RH               |
| Barometric Pressure                          | mmHg (selectable)  |

**Viewing a Single Parameter**

To view single parameters, press **FLOW/VOL**, **PRESSURE**, or **TIMING** repeatedly. If you are already viewing a multi-parameter screen, press **F2** (Single). The following is an example of the PIP single parameter screen:



ede26s.bmp

**Viewing a Group of Parameters**

From an individual parameter screen, press **F2** (All) to display the related screen of four parameters. The groups are Pressures, Vol/Flow, and Timing. The following is an example of the Pressures multi-parameter screen:

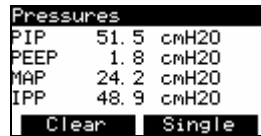

ede27s.bmp

**Viewing All Parameters**

You can view all 16 parameters on one screen when using the Analyzer connected to a PC running the VT for Windows software.

**Oxygen Screen**

Press **%RH O<sub>2</sub>** to access the Oxygen Screen. The sample oxygen screen shown below displays the signal and statistics for the oxygen sensor.



ede28s.bmp

Press **F1** (Clear) to reset the statistics and start a new reading.

Press **F2** (Calibrate) to begin the calibration routine for the oxygen sensor; you will find complete instructions later in this chapter.

### Temperature Screen

Press **[RH O<sub>2</sub>]** as required to access the Temperature Screen (available when the optional Temperature and Relative Humidity Sensor is connected.) The sample temperature screen shown below represents the gas temperature as measured in series with the High-Flow or Low-Flow Sensor.

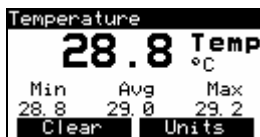

ede29s.bmp

### Relative Humidity Screen

Press **[RH O<sub>2</sub>]** as required to access the Relative Humidity Screen (available when the optional Temperature and Relative Humidity Sensor is connected.) The sample relative humidity screen shown below represents the gas relative humidity as measured in series with the High-Flow or Low-Flow Sensor.



ede30s.bmp

### Barometric Pressure Screen

Press **[MORE]** → **ENTER** to access the Barometric Pressure Screen. The Analyzer continuously measures the barometric pressure using an internal sensor. A sample barometric pressure screen follows:



ede31s.bmp

### Waveform Screens

You can access waveform representations of the reading by pressing keys in the WAVEFORM SCREENS section of the keypad. The Analyzer provides Flow, Pressure (high, low, and airway), and Volume waveform screens.

**Flow Screen**

Press **FLOW** to access the Flow Waveform Screen, which displays the reading and waveform for flow in the flow/low-pressure port of the Analyzer. The Analyzer automatically detects whether the High- or Low-Flow Sensor is connected. A sample flow waveform screen appears below:

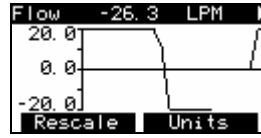

ede32s.bmp

Press **F2** to change the units of measure for the flow screen. Possible units of measure for this screen include:

- LPM: Liters per minute
- CFM: Cubic feet per minute
- LPS: Liters per second
- mL/min: Milliliters per minute
- mL/sec: Milliliters per second

Press **F1** to change the scale on the plot of data to a more appropriate window of values.

*Note*

*Rescale uses the current Min/Max values to determine plot limits.*

**Pressure Screen**

Press **PRESSURE** as required to access the Pressure Screen, which displays the reading and waveform for the pressure signal from the high-pressure or low-pressure/flow port. In order, sample high-pressure and low-pressure screens appear below:

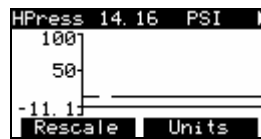

ede33s.bmp

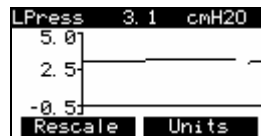

ede34s.bmp

Press **F2** to change the units of measure for the pressure screen. Possible units of measure for this screen include:

- mbar: millibar = .001 Bar
- bar: 14.7 PSIG (Barometric)
- mmHg: millimeters of mercury
- inHg: inches of mercury
- cmH<sub>2</sub>O: centimeters of water
- inH<sub>2</sub>O: inches of water
- PSIG: pounds per square inch
- atm: atmospheres
- kPa: kilopascals

Press **F1** (Rescale) to change the scale on the plot of data to a more appropriate window of values.

*Note*

*Rescale uses the current Min/Max values to determine plot limits.*

### Airway Pressure Screen

Press **PRESSURE** as required to access the Airway Pressure Screen (Paw), which displays the reading and waveform measured in the high- or low-flow port with the Analyzer connected between a ventilator and a test lung. The following is a sample Airway Pressure Screen:

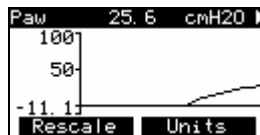

ede35s.bmp

### Volume Screen

Press **VOLUME** to access the Volume Screen. The volume screen displays the reading and waveform for the volume signal. The volume signal is the integral of the flow signal. A sample volume screen appears below:

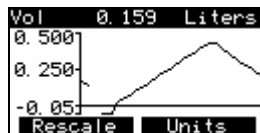

ede36s.bmp

Press **F2** (Units) to change the units of measure for the volume screen. Possible units of measure for this screen include:

- Liters Liters
- mL Milliliters
- CF Cubic Feet



Press **F1** (Rescale) to change the scale on the plot of data to a more appropriate window of values.

*Note*

*Rescale uses the current Min/Max values to determine plot limits.*

**Other Measurements Screens**

The Flow, Volume, and Pressure screens display the reading at the top of the screen and the minimum, maximum, and average of the readings at the bottom of the screen. The Analyzer calculates these statistics continually until you select a new screen or press **F1** (Clear).

**Flow Screen**

Press **FLOW/VOL** as required to access the Flow Screen, which displays the reading and statistics for flow in the flow/low-pressure port of the Analyzer. The Analyzer automatically detects whether the high- or low-flow sensor is connected. A sample flow screen appears below:

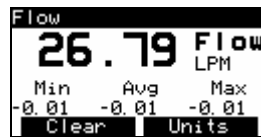

ede37s.bmp

Press **F2** (Units) to change the units of measure for the flow screen. Possible units of measure for this screen include:

- LPM – Liters per minute
- CFM – Cubic feet per minute
- LPS – Liters per second
- mL/min – Milliliters per minute
- mL/sec – Milliliters per second

Press **F1** (Clear) to reset the statistics and start a new reading.

**Volume Screen**

Press **FLOW/VOL** as required to access the Volume Screen, which displays the reading and statistics for the volume signal. The volume signal is the integral of the flow signal. A sample Volume Screen appears below:

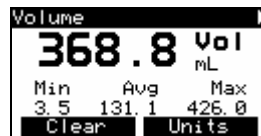

ede38s.bmp

Press **F2** (Units) to change the units of measure for the Volume Screen. Possible units of measure for this screen include:

- Liters    Liters
- mL      Milliliters
- CF      Cubic Feet

Press **F1** (Clear) to reset the statistics and start a new reading.

### **Pressure Screen**

Press **PRESSURE** to access the Pressure Screen, which displays the reading and statistics for the pressure signal from the high-pressure or low-pressure/flow port. A sample Pressure Screen appears below:



ede39s.bmp

Press **F2** (Units) to change the units of measure for the Pressure Screen. Possible units of measure for this screen include:

- PSIG – Pounds per square inch gauge
- kPa – Kilopascals
- bar – 14.7 PSIG
- mbar – millibar = .001 Bar
- atm – Atmosphere
- inH<sub>2</sub>O – Inches of water
- inHg – Inches of mercury
- cmH<sub>2</sub>O – Centimeters of water
- mmHg – Millimeters of mercury

### **Special Functions Screens**

Access the Trend Test, Zero Sensors, Barometric Pressure, and Battery screens with the keys at the bottom of the keypad.

### Trend Test Screens

Press **TREND TEST** to access the Trend Test screens, which allow you to record instances (or events) of a selected ventilator parameter falling outside limits that you establish. The opening screen in the trend test setup sequence appears below:

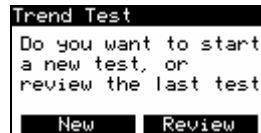

ede40s.bmp

### Zero Sensors Screens

Press **ZERO SENSORS** to access the Zero Sensors screens, which allow you to clear the offset resulting from drift inherent in the differential pressure transducer. The opening screen in the zero sensors sequence appears below:

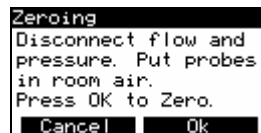

ede41s.bmp

This screen also appears automatically at a set interval to remind you to zero the sensors if Zero Warn is set to ON in the setup procedure.

### More Key Screens

#### Barometric Pressure Screen

Press **MORE** → **ENTER** to access the opening Barometric Pressure Screen, which allows you to view or change the barometric pressure that is automatically measured by an internal sensor. Under normal operating conditions, barometric pressure should not need adjustment. The following is a sample of the opening Barometric Pressure Screen:



ede31s.bmp

#### Battery Screen

Press **MORE** → **ENTER** to access the Battery Screen, which allows you to view the battery level. A sample of the 9-volt battery reading (when the battery eliminator is not connected) appears below:

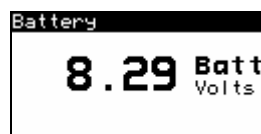

ede43s.bmp

If the battery eliminator is connected, this screen shows approximately 12 volts.

## Using Trend Test

Use Trend Test to examine a single breath parameter over an extended period. The Analyzer checks the parameter for deviations beyond the limits that you set. Set the limits in the units you are measuring.

Fluke Biomedical recommends that you disable the Zero Warn feature for the duration of your trend test. Zero warnings would otherwise interrupt the collection of events. Disable Zero Warn by pressing **ESC** → **ENTER** → **▼** → **▼** → **▼** → **ENTER** → **▼** (to Off) → **ENTER** → **F2**.

Use the following steps to advance through the trend test procedure:

1. Press **TREND TEST** to begin the Trend Test setup.

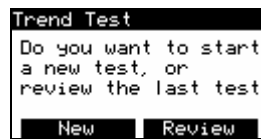

ede45s.bmp

2. Press **F1** (New) to begin a new trend test.



ede44s.bmp

3. Press **▲** or **▼** to select the trend parameter for the test (VT, MV, PIF, PEF, Rate, Ti, Te, PIP, PEEP, MAP, or IPP.)
4. Press **ENTER** to activate the parameter selection.

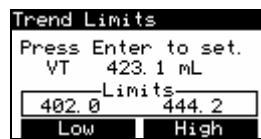

ede40s.bmp

5. Press **F1** (Low) and then set the low limit by either:
  - a. Pressing **▲** or **▼** to increment or decrement the displayed value 0.1 units at a time, or
  - b. Using the text entry keys to enter a new value directly.
6. Press **ENTER** to accept this value.
7. Press **F2** to enter the High limit, and repeat the entry procedure.

- When both Low and High limit values are correct, press **ENTER** again to advance to the Start Trend Test screen.



ede46s.bmp

- Before starting the test, ensure that the ventilator is on, has reached steady-state conditions, and that the displayed breath parameter is as expected. Press **F2** (Start) to begin the test.
- The Analyzer displays the Trend Test screen while the trend test is in progress. The trend test screen shows the parameter being tested, the current value, the upper and lower limits, and the number of events (readings falling outside the limits.)

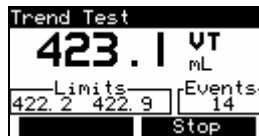

ede47s.bmp

- To terminate the test, press **F2** (Stop). The Trend Summary screen appears. If there are no events, the Trend Summary screen is not available.

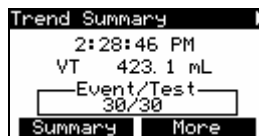

ede48s.bmp

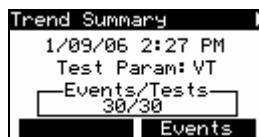

ede49s.bmp

- Alternatively, press **F2** (More) to display related parameters.

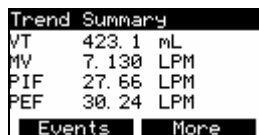

ede50s.bmp

## Making Measurements

This Operators Manual covers specific measurement procedures in the following chapters:



- Chapter 4: Checking Ventilator Parameters. Learn how to set up and take measurements for the 16 ventilator parameters.
- Chapter 5: Measuring Pressure. Learn how to set up and take pressure measurements using the High- and Low-Pressure adapters.
- Chapter 6: Measuring Flow and Volume. Learn how to set up and take flow and volume measurements using the High- and Low-Flow sensors.

## Working with Memory

Access Analyzer memory by pressing . The following screen appears:



ede51s.bmp

Press  or  to highlight an item, and then press **ENTER** to make the selection.

Store all existing readings by selecting Save New File. The Analyzer prompts you for a file name to Save As; use the text entry keys to enter a name. Then press **ENTER** and wait for a moment while the Analyzer stores the readings to this file.

Retrieve an existing file by selecting View File, scrolling to the file name, and then pressing **ENTER**. You can view the DEMO file in this fashion; it provides sample data for all possible measurements.

Delete a single file by selecting Delete File, scrolling to the file to delete, and pressing **ENTER**.

Delete all files by pressing Delete All and then pressing **ENTER**.

## Printing

Print data from the Analyzer using a PC running VT for Windows. This software also allows you to view all 16 ventilator parameters on one screen and manipulate and graph data.

## Making a Measurement More Accurate

### Warm-up and Zeroing

The Analyzer requires a warm-up period. A five-minute warm-up followed by a zero and immediate measurement is adequate for most applications. A 40-minute warm-up ensures maximum accuracy and stability.

The Zero Warn feature reminds you to zero the transducers at predefined intervals. Fluke Biomedical strongly recommends that you leave Zero Warn ON and, after removing pressure and flow sources, zero the transducers whenever the Zero Warn message appears.

The Analyzer requires you to zero immediately after power on. If Zero Warn is ON, the Analyzer prompts you for an optional zero after the first five minutes and then after each subsequent 30-minute interval. To zero at the prompt, follow these steps:

1. Place the Analyzer on a flat surface with sensors/adapters disconnected at the Analyzer (Figure 3-2.)

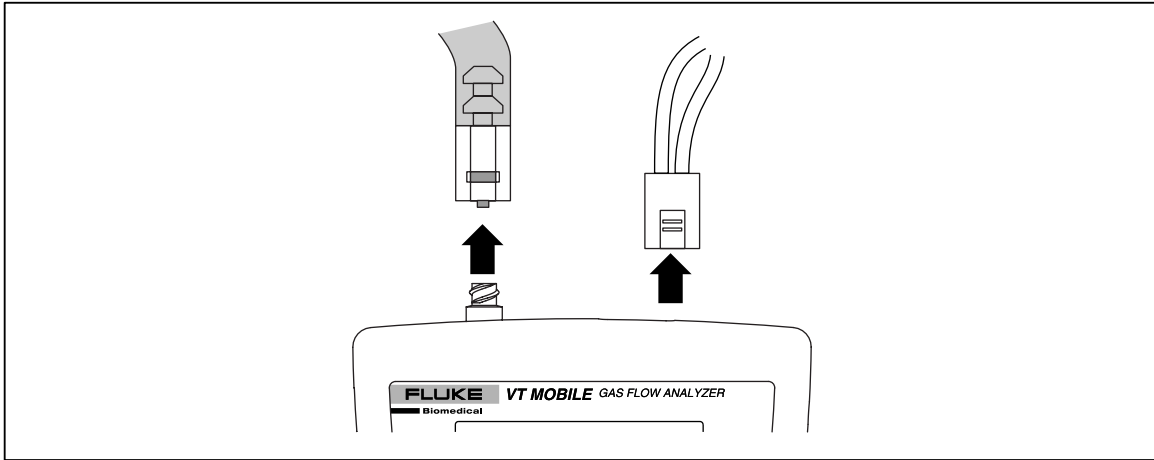

Figure 3-2. Flow Sensors and Pressure Adapters Disconnected

edg17f.eps

2. Press **F2**. Press **ZERO SENSORS** at any time to initiate an unprompted zero. Generally, it is appropriate to zero before any pressure or flow measurement.
3. Reconnect the sensors/adapters (Figure 3-3.)

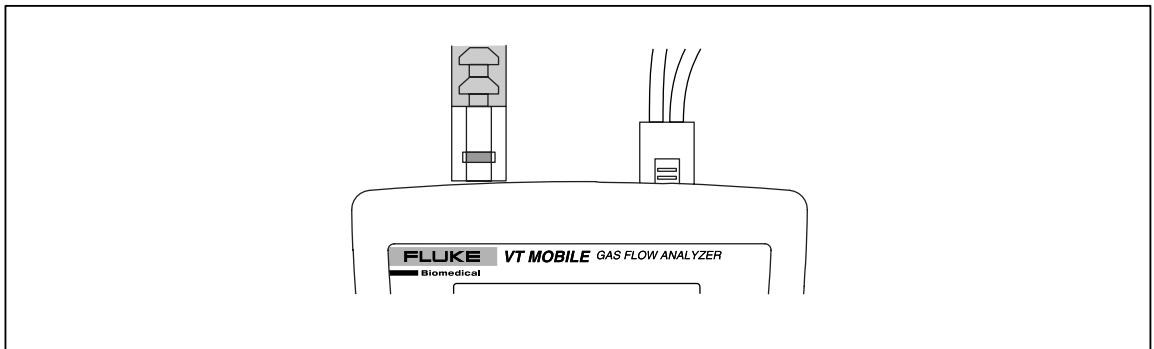

Figure 3-3. Flow Sensors and Pressure Adapters Connected

edg18f.eps

## **Oxygen Sensor**

The Analyzer calculates the oxygen percentage as the fraction of the partial pressure of oxygen relative to the total pressure. Note that changes in the total pressure (i.e. airway pressure) result in a change in the partial pressure of the measured oxygen even though the percentage of oxygen is the same. Since the pressure can change much faster than the response time of the oxygen sensor, a small transient (1 to 2% of full-scale) error can occur in the oxygen measurement when there is a fast change in the pressure at the oxygen sensor.

Whenever you make an oxygen measurement, or when you calibrate or zero the oxygen sensor, make sure there is sufficient gas flow past the oxygen sensor. The Analyzer needs only a small flow of gas (e.g., 10 lpm) to ensure that the oxygen concentration at the oxygen sensor is measured accurately. A small amount of flow must be present to ensure gas mixing.

## **Verifying Oxygen Sensor Calibration**

Verify the oxygen sensor calibration at the beginning of any day during which you expect to measure oxygen concentrations. Note that you must calibrate the Oxygen Sensor before initial verification; the sensor is not calibrated as shipped. The Oxygen Sensor requires subsequent weekly recalibration at a minimum.

Use the following verification procedure:

1. Connect the Oxygen Sensor as shown in Figure 3-4.
2. Introduce a 10 lpm or greater flow of 100% oxygen through the Oxygen Sensor “T”.
3. Press  to access the O2 display.
4. Ensure that the O2 screen oxygen concentration is 100 % ± 2 % of full scale. If the concentration is less than 98 %, perform the oxygen sensor calibration as described below.
5. Replace the oxygen sensor after one year (or longer if no replacement message appears during calibration.)

### *Note*

*The Oxygen Sensor is not calibrated at the factory.*

## **Calibrating the Oxygen Sensor**

Calibrating the Oxygen Sensor improves pressure compensation for barometric and airway pressure changes. Figure 3-4 portrays Oxygen Sensor connections.



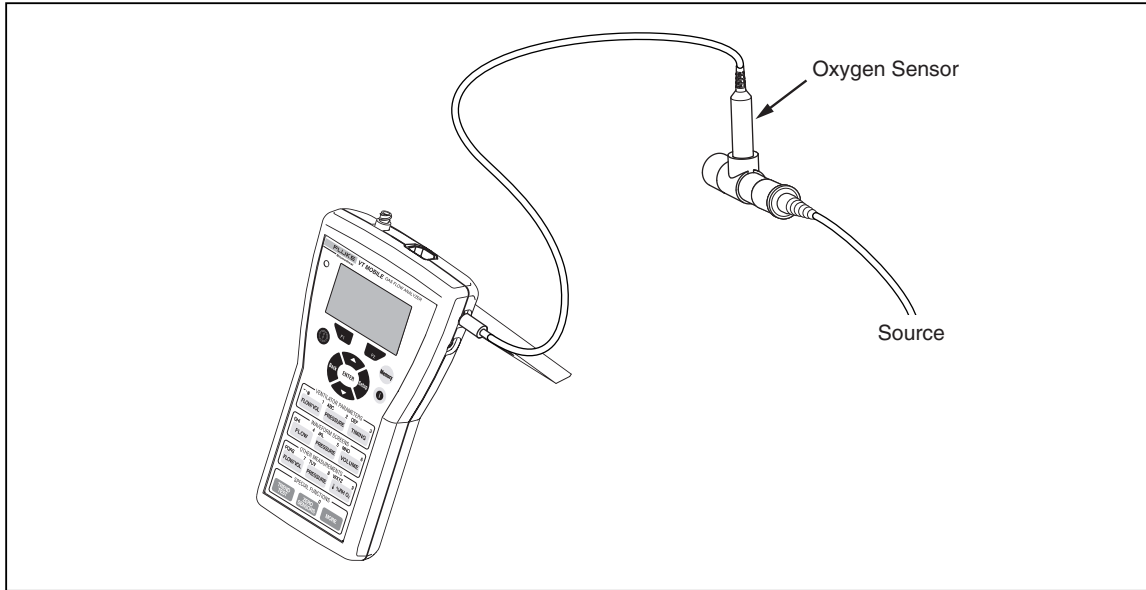

edg20f.eps

**Figure 3-4. Oxygen Sensor Calibration**

1. Press **⏏ %RH O<sub>2</sub>** to display the Oxygen measurement screen.
2. Press **F2** to access the Oxygen calibration screen.



ede28s.bmp

3. Connect the High-Flow Sensor and then apply dry air (20.9 % oxygen) at 10 lpm to either side of the sensor.
4. Press **F1** twice to access the Calibration screen. Wait for the two-minute timer to count down.
5. Apply 100 % oxygen at 10 lpm.
6. Press **F2** twice and then press **F1** once to access the Calibration screen.
7. After the two-minute interval, the Oxygen measurement screen appears and the calibration is complete.

### **Using the Temperature and Relative Humidity Sensor**

Use the optional Temperature and Relative Humidity Sensor to compensate for the conditions of the gas flowing through the High- or Low-Flow Sensor. The Analyzer uses the gas temperature to improve the accuracy of the flow measurements. Relative humidity readings provide a reference point for some correction factors. Connect this sensor to the Analyzer as shown in Figure 3-5.

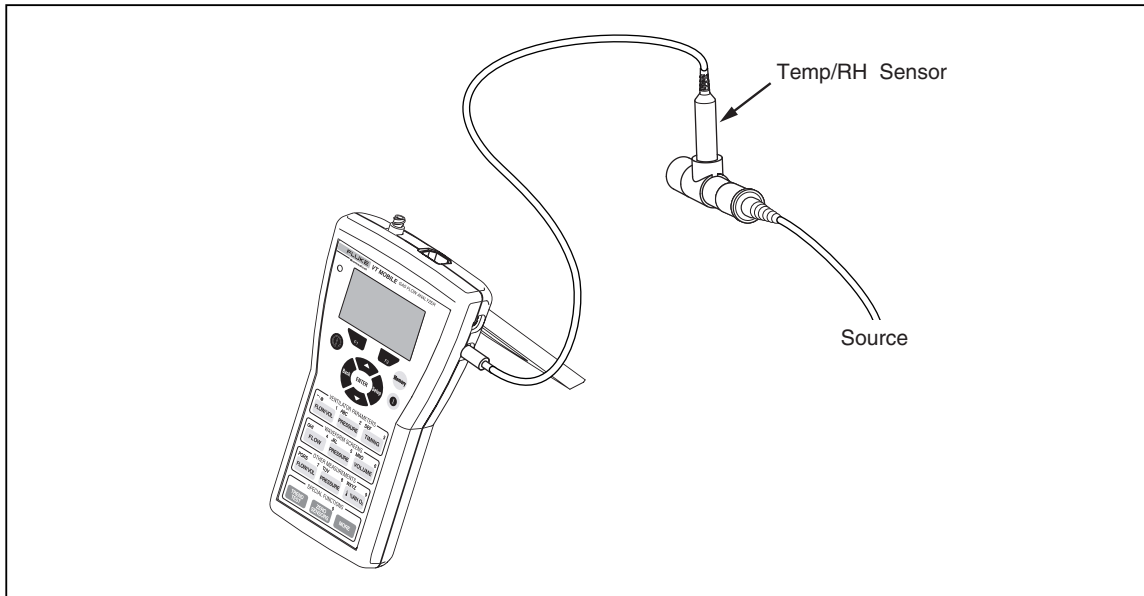

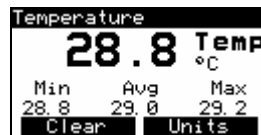

Figure 3-5. Measuring Temperature and Relative Humidity

ede19f.eps

Press  as required to access the temperature and relative humidity screens shown below:



ede29s.bmp



ede30s.bmp

### Checking Barometric Pressure

Other pressures displayed on the Analyzer (e.g., Airway Pressure, differential pressures as a basis for Flow, etc.) are relative to the internally-measured barometric pressure (gauge pressure).

An internal sensor constantly measures barometric pressure. Other pressures displayed on the Analyzer (e.g., airway pressure or differential pressure as a basis for flow) are relative to the internally-measured barometric pressure (gauge pressure). You can fine-tune the barometric pressure measurement by entering your own value. The Analyzer then factors in the difference between the original measurement and your value as an offset correction for subsequent measurements. The Analyzer stores the correction factor in non-volatile memory to be remembered when you turn it off and then back on.

To enter a barometric pressure value, follow these steps:

1. Disconnect the High-Pressure Adapter at the High-Pressure Port.
2. Press  → **ENTER** to access the barometric pressure screen, shown below.



ede31s.bmp

3. Press **F1** to access the calibration screen. This screen always appears in mmHg units even though you may have selected other units.
4. Use the text entry keys to enter the barometric pressure in mmHg.
5. Press **ENTER** to return to the barometric pressure screen.

Note that the Analyzer accepts barometric pressure values between 0.0 and 999.9 mmHg.

#### Note

*Exercise caution in changing barometric pressure readings; correct barometric pressure yields more accurate pressure, flow, and volume readings. Under normal operating conditions, barometric pressure should not need adjustment.*

*The Analyzer relies on ambient barometric pressure. Do not set for airport barometric pressure, which is corrected for altitude.*

### Changing Barometric Pressure Units

To change the barometric pressure units, follow these steps:

1. Press **MORE** → **ENTER**.
2. Press **F2** successively to select a barometric pressure unit. Units available are: mmHg, PSI, kPa, Bar, mBar, ATM, inH2O, InHg, and cmH2O.
3. Press **EXIT** to return to the active display.

### Viewing Demo Data

This function allows you to show recorded data on screen without needing to hook up to a ventilator or do any measurements. The recorded data is for "demonstration" purposes.

To select this function, follow these steps:

1. Press **Memory** to access the Files screen.
2. Press **Left Arrow** as necessary to highlight 'View File'.
3. Press **ENTER** and then press **Left Arrow** as necessary to highlight 'DEMO'.
4. Press **ENTER** to activate your selection. After a pause, the Analyzer returns to a measurement screen displaying data from the demo file.
5. To stop the demo data display, press **Memory** to access the Files screen, highlight 'Stop Playback', and then press **ENTER** to exit the demo file. Press any measurement key to continue with live measurements.

### Accessing Help

Use the **i** key to access context-sensitive help. If additional text is available off screen, a vertical bar appears on the right side of the help screen. Use **Left Arrow** or **Right Arrow** to scroll through the complete text. Press **F2** to exit help.



## Chapter 4

# Checking Ventilator Parameters

### Introduction

To monitor ventilator parameters, the Analyzer must first determine when a breath occurs and delineate the various phases of the breath. For example, the breath detection algorithm determines the beginning and ending of the integration periods for calculating tidal volumes.

The breath detection algorithm is a state machine. The flow waveform is the input to the state machine. The Analyzer bases state changes on flow waveform crossings of predefined thresholds. The breath detection threshold can be set to a high flow rate to reject noise near zero flow.

You can use the High-Flow or Low-Flow Sensor to sample ventilator parameters. Generally, the Low-Flow Sensor provides better accuracy at low flow rates (less than 25 lpm). Also, review “Making a Measurement More Accurate” in Chapter 3 for a discussion of the uses of the Oxygen Sensor, Temperature and Relative Humidity Sensor, and barometric pressure readings in enhancing measurement accuracy. Chapter 3 also discusses proper warm-up and zeroing procedures to compensate for sensor drift.

### Checking Ventilator Parameters

Refer to Figure 4-1 when you are connecting the Analyzer to a ventilator and test lung.

1. Press  and follow on-screen instructions.
2. At the Analyzer, connect the High-Flow Sensor to the Flow/Low-Pressure Port.
3. Connect the Oxygen Sensor to the upper port on the right side of the Analyzer.
4. If available, connect the optional Temperature/RH Sensor to the lower port on the right side of the Analyzer.

- Using parts from the Accessory Kit and the connectors provided with the sensors, make connections between the ventilator and the ACCU LUNG as shown in Figure 4-1. Use the sequence: ventilator Y connector → High-Flow Sensor (blue stripe toward the ACCU LUNG) → Temperature/RH Sensor → Oxygen Sensor → ACCU LUNG. Vertically align all sensors.
- Set up the ventilator for a characteristic breath pattern. For example, you could set 10 BPM at 7.5 lpm.
- Set the ACCU LUNG for C20 compliance (both outer springs engaged) and Rp50 resistance (positioned as shown in Figure 4-1.)

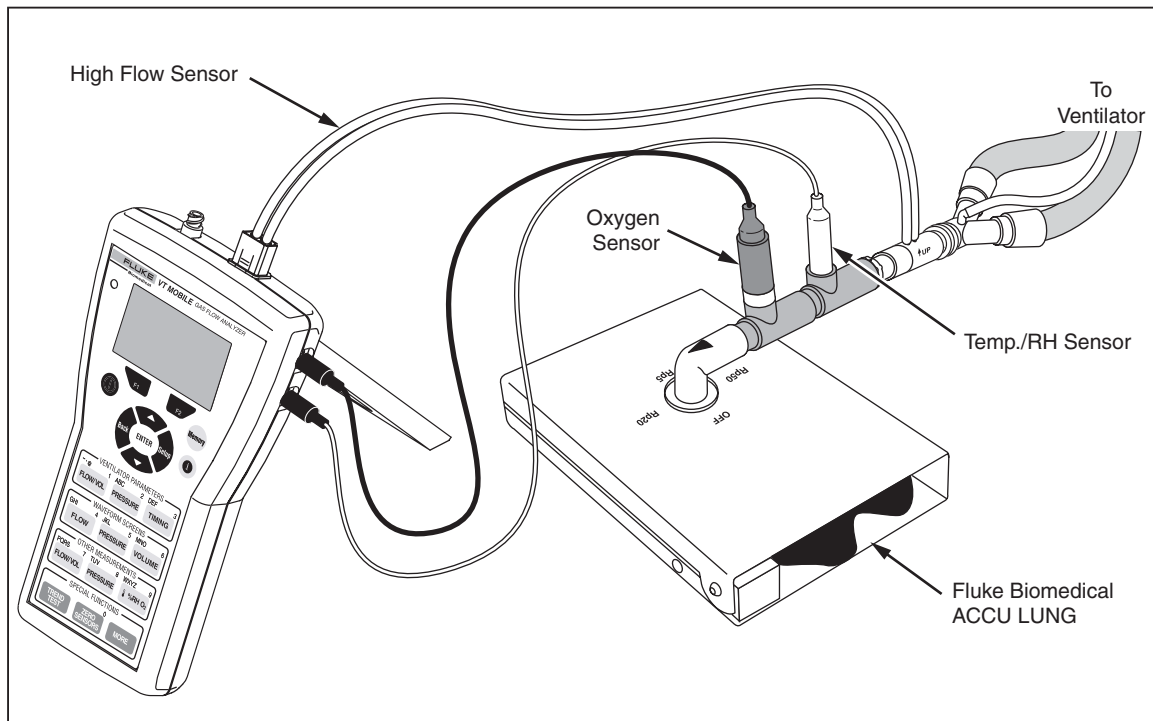

**Figure 4-1. Ventilator Connections**

ede06f.eps













- Apply power to all elements of the test setup. For the Analyzer, press **⏻** on, wait for the Zeroing screen, and then press **F2**. The Analyzer is ready to use once the Tidal Volume screen appears.
- Press the access keys shown in Table 4-1 to display the various ventilator parameters. Once you have pressed the first key, you can continue pressing that key to view other parameters or press **F2** to view all the parameters.
- As described in Table 4-1, the Analyzer calculates 16 breath parameters in Local Mode. Note that you can view all 16 parameters and other information on one screen in Remote mode when using the VT for Windows software.
- Figure 4-2 shows the ventilator parameter screens.
- Figure 4-3 shows additional oxygen, temperature, relative humidity, and barometric pressure parameter screens.

## Understanding the Parameters

Table 4-1 presents a list of parameters calculated by the Analyzer. A breath detection algorithm determines the various phases of a ventilator breath; the Analyzer then calculates the first 12 parameters. The Analyzer provides the final four parameters as direct measurements.

Figure 4-2 shows how to access the 12 calculated parameters, and Figure 4-3 shows how to access the four direct measurement parameters.

**Table 4-1. Ventilator Parameters**

| Keys   | Item | Name                                 | Description  |
|--|------|--------------------------------------|--|
| <br><br>     | VT   | Tidal Volume                         | Total volume accumulated over the Inspiratory Time.  |
|  | MV   | Minute Volume                        | The Expiratory Tidal Volume times the respiratory rate in breaths per minute.                  |
|  | PIF  | Peak Inspiratory Flow                | The maximum of the absolute value of the Flow Rate measured during the Inspiratory Time.       |
|  | PEF  | Peak Expiratory Flow                 | The maximum of the absolute value of the Flow Rate measured during the Expiratory Time.        |
| <br><br>   | PIP  | Peak Inspiratory Pressure            | The maximum pressure during the Inspiratory Time.  |
|  | PEEP | Positive End-Expiratory Pressure     | The average pressure during the End Expiratory State.  |
|  | MAP  | Mean Airway Pressure                 | The mean pressure over the entire breath.  |
|  | IPP  | Inspiratory Pause Pressure           | The average pressure during the End Inspiratory State.   |
| <br><br> | Rate | Breath Rate                          | Number of breaths per minute.  |
|  | Ti   | Inspiratory Time                     | The time of the inspiratory period including the inspiratory hold time.                        |
|  | Te   | Expiratory Time                      | The time of the expiratory period including the expiratory hold time.                          |
|  | I:E  | Inspiratory to Expiratory Time Ratio | The ratio of the Inspiratory Time to the Expiratory Time.                                      |
|   | O2   | Oxygen Percentage                    | The percentage of oxygen to total gas.   |
|          | Temp | Temperature                          | The temperature of the gas passing through the Temperature and Relative Humidity Sensor.       |
|          | RH   | Relative Humidity (gas under test)   | The relative humidity of the gas passing through the Temperature and Relative Humidity Sensor. |
|          | Baro | Barometric Pressure                  | The absolute barometric pressure as measured internally.                                       |

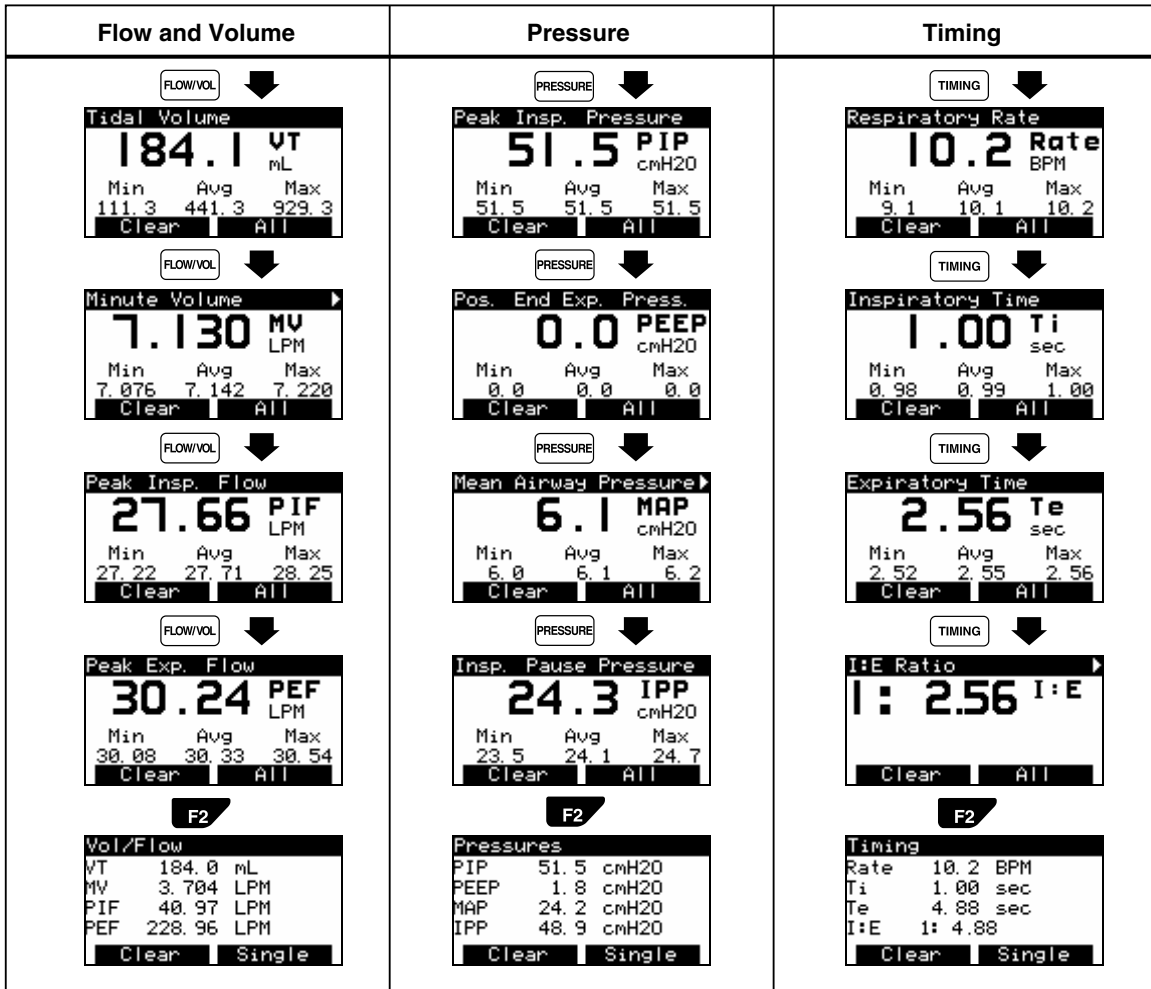

Figure 4-2. Accessing Calculated Parameters

edg52f.eps

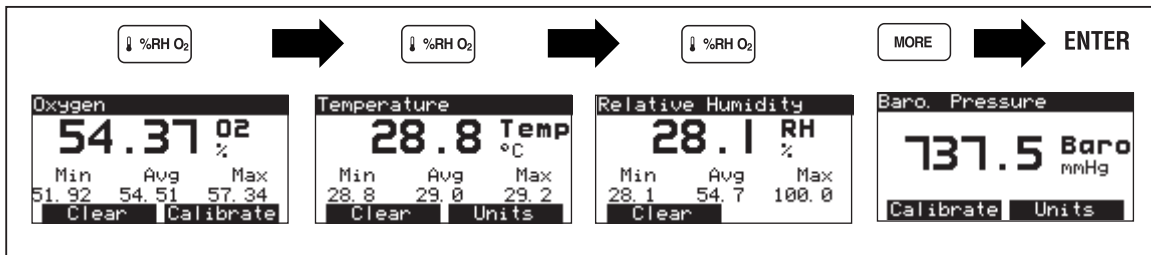

Figure 4-3. Accessing Other Parameters



edg12f.eps



# Chapter 5

## Measuring Pressure

### Introduction

The Analyzer detects a Low-Pressure Adapter connection to the Flow/Low-Pressure Port. With the Low-Pressure Adapter disconnected, pressing  under WAVEFORM SCREENS or OTHER MEASUREMENTS toggles between high pressure and airway pressure. With the Low-Pressure Adapter connected, pressing  successively selects high pressure, low pressure, or airway pressure.

With a pressure connection, the measurement is equivalent to a gauge measurement. For gauge pressures, the measurement is relative to the ambient (barometric) pressure.

Do not use either the High-Pressure or Low-Pressure Adapter for fluid measurement. If fluid enters into the pressure measurements connections of the Analyzer, evacuate the fluid before storage and before you make any pressure measurements. You can evacuate the fluid by connecting a 100 cc syringe directly to the pressure measurement connection and then pulling back the syringe to create a vacuum.

Review “Making a Measurement More Accurate” in Chapter 3 for a discussion of the uses of the Oxygen Sensor, Temperature and Relative Humidity Sensor, and barometric pressure readings in enhancing measurement accuracy. Chapter 3 also discusses proper warm-up and zeroing procedures to compensate for sensor drift.

## Measuring Low Pressure

Measure low pressure in the range: -20 to 120 cmH<sub>2</sub>O. Never exceed an absolute maximum of 5 psi (0.345 bar).

Refer to Figure 5-1 while following these steps:

1. Press **ZERO SENSORS** and follow on-screen instructions.
2. At the Analyzer, connect the Low-Pressure Adapter to the Flow/Low-Pressure Port.
3. Press **PRESSURE** in the OTHER MEASUREMENTS or WAVEFORM SCREENS section.
4. Verify that the screen displays Low Pressure (Plo) or LPress. If the High-Pressure Adapter is also connected, you may need to press **PRESSURE** a second time.
5. Connect the Low-Pressure Adapter to the source.
6. Apply pressure.
7. Successively press **F2** (Units) to select a pressure unit in the sequence: PSI → kPa → Bar → mBar → ATM → inH<sub>2</sub>O → InHg → cmH<sub>2</sub>O → mmHg.

If the waveform is too small or too large, press **F1** (Rescale) to view the waveform within optimized limits.

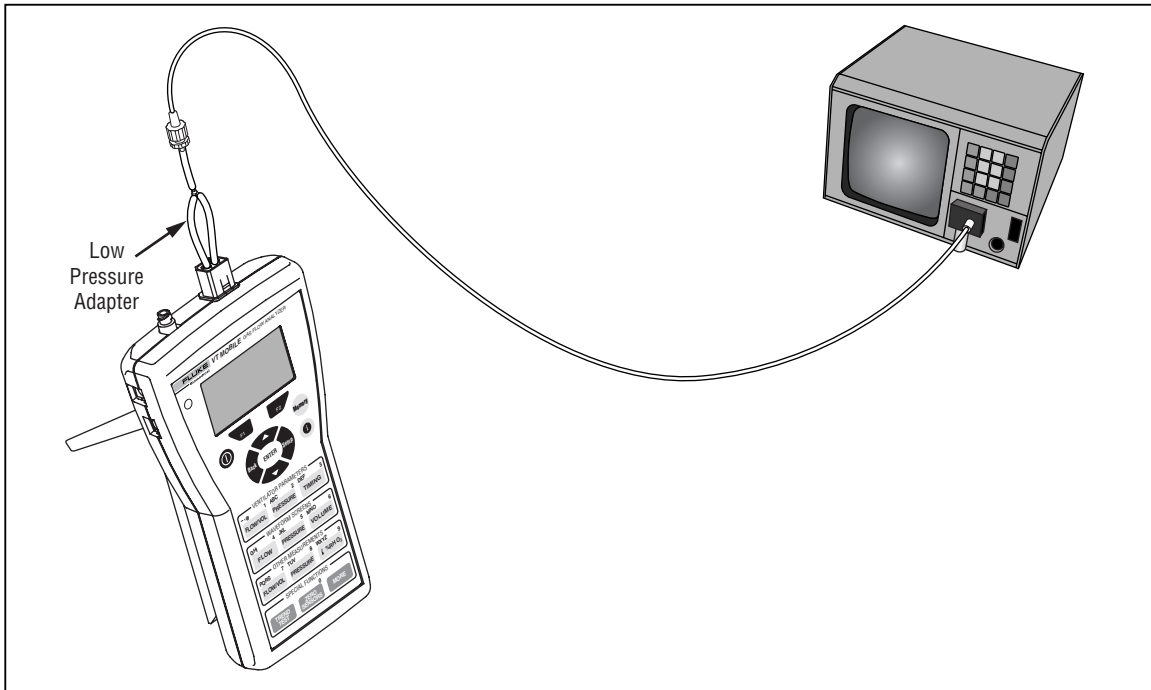

Figure 5-1. Measuring Low Pressure

edg08f.eps

Figure 5-2 shows some characteristic low-pressure screens.

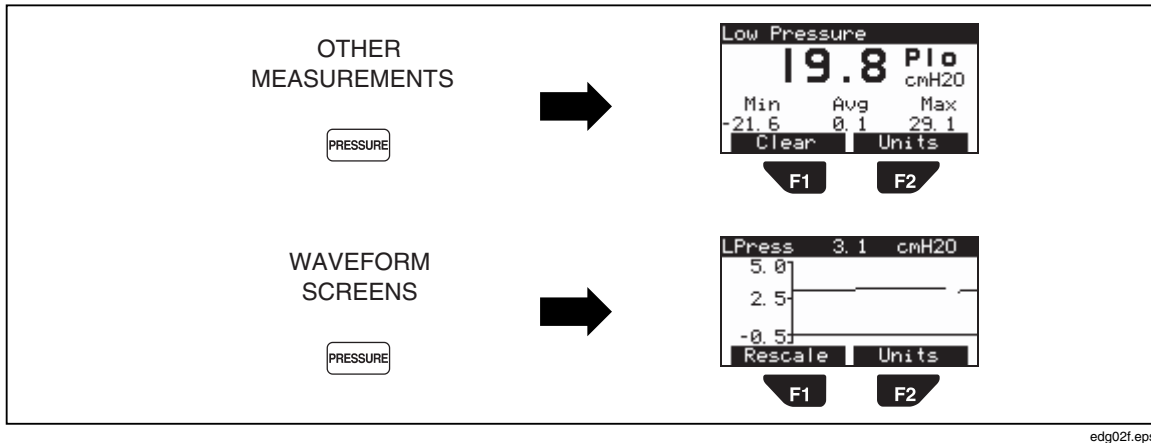

Figure 5-2. Accessing Low-Pressure Measurements

## Measuring High Pressure

The Analyzer can measure high pressure from -2 to 100 psi. Be certain of your possible source pressure before measuring high pressure. For example, normal bulkhead outlet pressure could be too high. Unregulated cylinder pressure could also be too high.

Refer to Figure 5-3 while following these steps:

1. Press **ZERO SENSORS** and follow on-screen instructions.
2. At the Analyzer, connect the High-Pressure Adapter to the high-pressure port.
3. Press **PRESSURE** in the OTHER MEASUREMENTS or WAVEFORM SCREENS section.
4. Verify that the screen displays High Pressure (Phi) or HPress. If the Low-Pressure Adapter is also connected, you may need to press **PRESSURE** a second time.
5. With the high-pressure source set to zero output, connect the High-Pressure Adapter to the source. Note that various connection schemes are available.
6. Apply pressure.
7. Successively press **F2** (Units) to select a pressure unit in the sequence: PSI → kPa → Bar → mBar → ATM → inH2O → InHg → cmH2O → mmHg

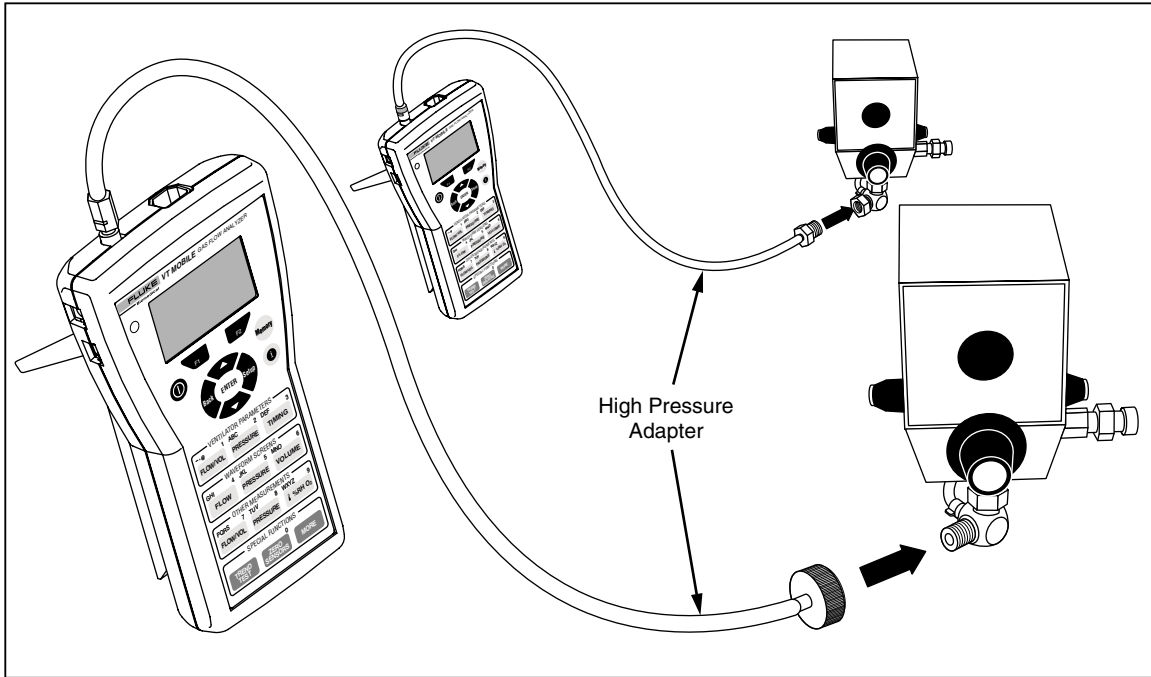

Figure 5-3. Measuring High Pressure

edg11f.eps

For waveform pressure readings, press **F1** (Rescale) to optimize waveform viewing.

**⚠ Warning**

**Always turn pressure off at the source prior to disconnecting either end of the High-Pressure Adapter. Serious injury could otherwise result.**

Figure 5-4 shows some characteristic high-pressure screens.

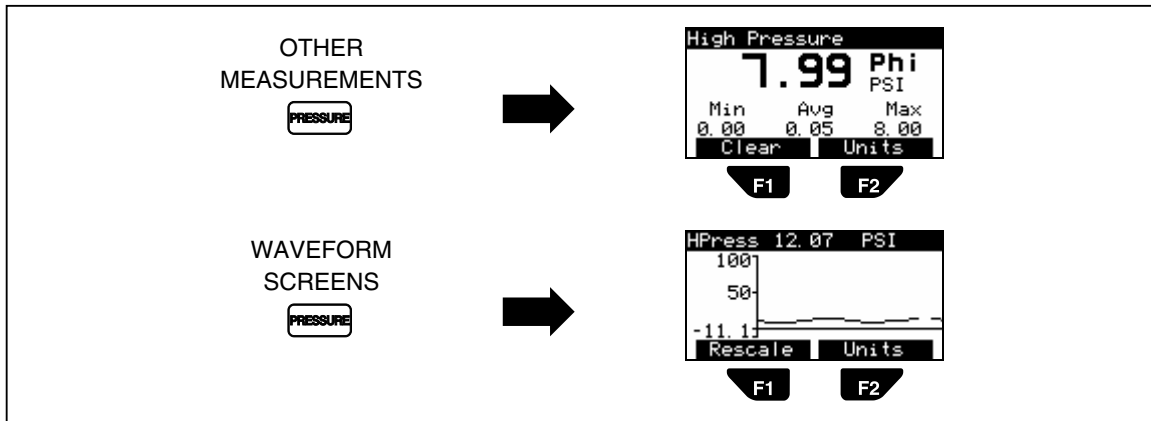

Figure 5-4. Accessing High-Pressure Measurements

edg04f.eps

## Measuring Airway Pressure

The Analyzer uses the same pressure transducer for low pressure and airway pressure measurements. It derives airway pressure internally through the connections for high- or low-flow measurements. Consequently, airway pressure measurements are available with the High- or Low-Flow Sensor connected during ventilator parameter checks.

Figure 5-5 illustrates ways to view the airway pressure.

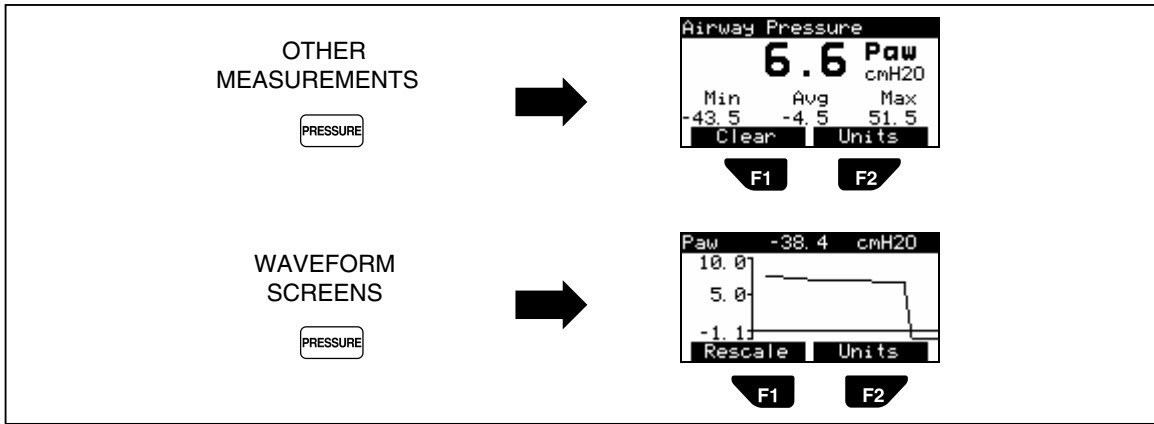

Figure 5-5. Accessing Airway Pressure Measurements

edg05f.eps



# Chapter 6

## Measuring Flow and Volume

### Introduction

The Analyzer makes flow measurements by measuring the differential pressure across a fixed orifice flow sensor. The resulting differential pressure is nearly linear with respect to the volumetric flow. The Analyzer applies simple corrections to correct for any non-linearities.

Also, review “Making a Measurement More Accurate” in Chapter 3 for a discussion of the uses of the Oxygen Sensor, Temperature and Relative Humidity Sensor, and barometric pressure readings in enhancing measurement accuracy. Chapter 3 also discusses proper warm-up and zeroing procedures to compensate for sensor drift.

### Gas Settings

The flow measurement sensors in the Analyzer are linearly dependent on the viscosity of the applied gas. The Analyzer setup options allow you to specify the type of gas in use. Additional choices are available using the User Defined gas settings available with the VT for Windows software. The gas calculator in the VT for Windows software can determine the effective viscosity for a combination of various gases.

Use of the Temperature and Relative Humidity Sensor increases flow and volume accuracy. The Analyzer calculates the temperature dependent viscosity for the gas type selected (except for user-defined gases). Therefore, when the sensor measures a new flowing gas temperature, the Analyzer calculates the new viscosity. The Analyzer viscosity calculation for the gas settings assumes the use of dry gas. Increased water vapor content can slightly affect the flow accuracy.

#### *Note*

*Never apply humidified gases to the Analyzer flow sensors. Condensation on the flow sensors causes errors in the flow readings until you dry condensation from the flow sensors.*

### Balance Gas Settings

You can use gas combinations with oxygen. For example, the Analyzer can be set to use Helium balance Oxygen (Heliox.) In this mode, the Analyzer uses the oxygen measurement to determine the oxygen concentration and then assumes the balance of the gas concentration is helium. The Analyzer calculates the effective viscosity for the combination gas at the measured temperature. The oxygen concentration used for the balance gases updates automatically.

### Correction Modes

The Analyzer obtains the ambient pressure from the measured barometric pressure. The optional Temperature and Relative Humidity Sensor supplies the measured gas temperature and relative humidity. Table 6-1 describes correction modes that are dependent on these measurements.

**Table 6-1. Correction Modes**

| Mode               | Name   | Description  |
|--------------------|--|--|
| ATP                | Ambient Temperature and Pressure                         | The Analyzer corrects the flow rate (and therefore, volume) such that the reported flow equals the flow if the gas temperature and pressure are at ambient (room) temperature and pressure.  |
| BTPS               | Body Temperature and Pressure Saturated with water vapor | The Analyzer corrects the flow rate (and therefore, volume) such that the reported flow equals the flow if the gas temperature and pressure were changed to body conditions (37 °C and ambient pressure). Further, the Analyzer compensates the flow to add the amount of water vapor as if to make the gas fully saturated (i.e. 100% relative humidity). In this correction, the Analyzer uses the relative humidity reading to determine the amount of water vapor that would need to be added. |
| STPD <sub>0</sub>  | Standard Temperature and Pressure Dry, 0 °C              | The Analyzer corrects the flow rate (and therefore, volume) such that the reported flow equals the flow if the gas temperature and pressure were changed to standard conditions (0 °C and 760 mmHg). Further, the Analyzer compensates the flow to subtract the amount of water vapor as if the gas was dry (i.e. 0% relative humidity). In this correction, the Analyzer uses the relative humidity reading to determine the amount of water vapor that would need to be subtracted.              |
| STPD <sub>21</sub> | Standard Temperature and Pressure Dry, 21 °C             | The Analyzer corrects the flow rate (and therefore, volume) such that the reported flow equals the flow if the gas temperature and pressure were changed to standard conditions (21°C and 760 mmHg). Further, the Analyzer compensates the flow to subtract the amount of water vapor as if the gas was dry (i.e. 0% relative humidity). In this correction, the Analyzer uses the relative humidity reading to determine the amount of water vapor that would need to be subtracted.              |

### Flow Zeroing

The zero function can be set to prompt you automatically at pre-determined intervals or only when you request the function by pressing . The Analyzer Zero Warn is set to ON at the factory to remind you to zero out any offset in the Flow measurements. The Zero Warn screen reminds you at power on, after the first five minutes, and then after each 30-minute period. After the power-on zero warning, you can choose to Zero or Cancel when the reminder appears; either action returns the Analyzer to the same function.

#### Caution

**Setting Zero Warn to OFF may result in introduction of offset into the Flow and Volume measurements and cause errors in the assessment of those measurements against the medical device under test specification. Fluke Biomedical strongly recommends that you leave Zero Warn ON.**

The differential pressure transducer used to measure the flow rate is subject to baseline (offset) drift. You will see this most pronounced during the Analyzer warm-up period. For maximum accuracy, observe a 40-minute warm-up, followed by the zeroing procedure.



## Measuring Low Flow

Measure low flow in the range: +/- 25 lpm. Never exceed an absolute maximum of 35 lpm. Refer to Figure 6-1 while following these steps:

1. At the Analyzer, connect the Low-Flow Sensor to the Flow/Low-Pressure Port.
2. Press **ZERO SENSORS** and follow on-screen instructions.
3. Press **FLOW/VOL** (in OTHER MEASUREMENTS) or **FLOW** (in WAVEFORM SCREENS.)
4. Connect the Low-Flow Sensor to the source.
5. Apply flow.
6. Successively press **F2** (Units) to select a flow unit in the sequence: LPM → CFM → LPS → ml/min → ml/sec.

If the waveform is too small or too large, press **F1** (Rescale) to view the waveform within optimized limits.

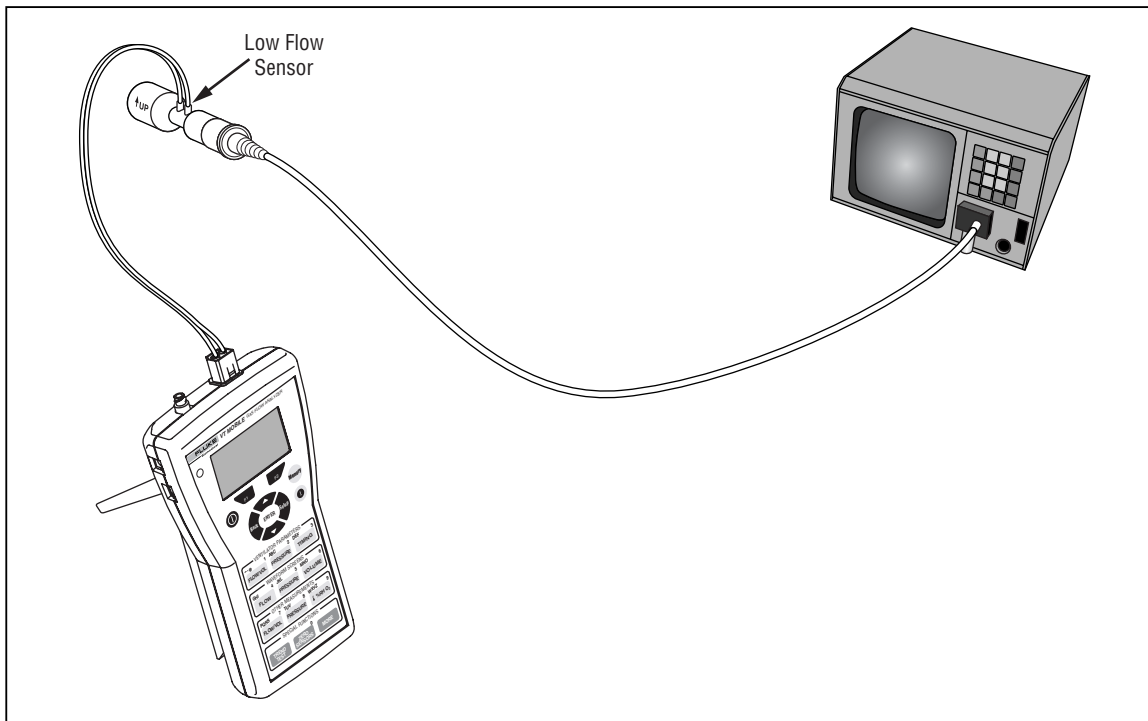

Figure 6-1. Measuring Low Flow

edg13f.eps

Figure 6-2 shows some characteristic low-flow screens.

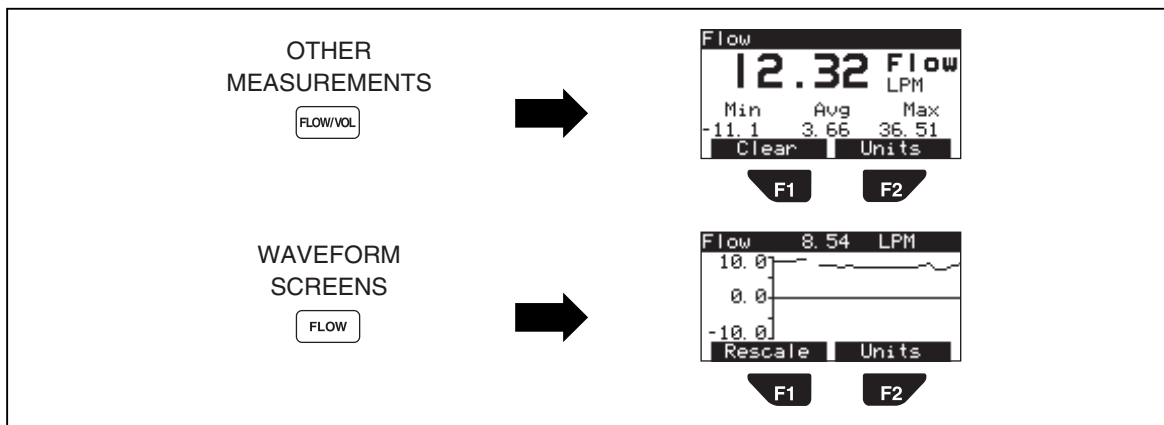

Figure 6-2. Accessing Low-Flow Measurements

edg15f.eps

## Measuring High Flow

Measure high flow in the range:  $\pm 150$  lpm. Never exceed an absolute maximum of 200 lpm. For flow rates below 25 lpm, use the Low-Flow Sensor. Refer to Figure 6-3 while following these steps:

1. At the Analyzer, connect the High-Flow Sensor to the Flow/Low-Pressure Port.
2. Press **ZERO SENSORS** and follow on-screen instructions.
3. Press **FLOW/VOL** (in OTHER MEASUREMENTS) or **FLOW** (in WAVEFORM SCREENS.)
4. Connect the High-Flow Sensor to the source.
5. Apply flow.
6. Successively press **F2** (Units) to select a flow unit in the sequence: LPM  $\rightarrow$  CFM  $\rightarrow$  LPS  $\rightarrow$  ml/min  $\rightarrow$  ml/sec.

If the waveform is too small or too large, press **F1** (Rescale) to view the waveform within optimized limits. Refer to Figure 6-4 for sample screens.

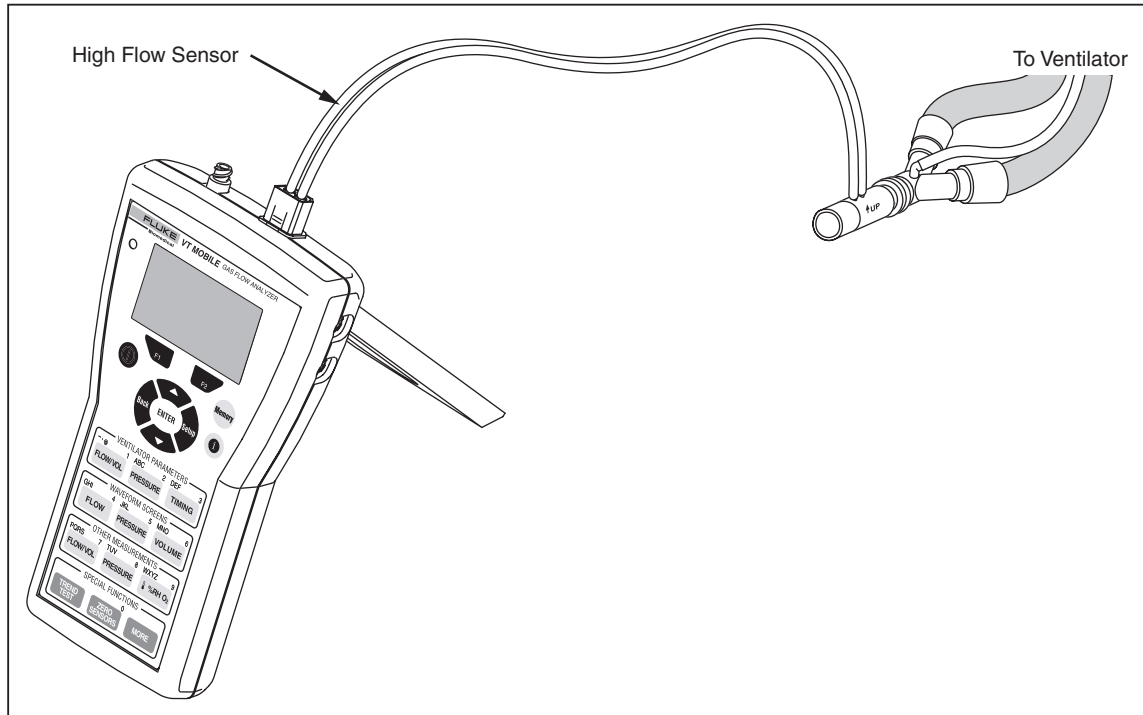

Figure 6-3. Measuring High Flow

edg24f.eps

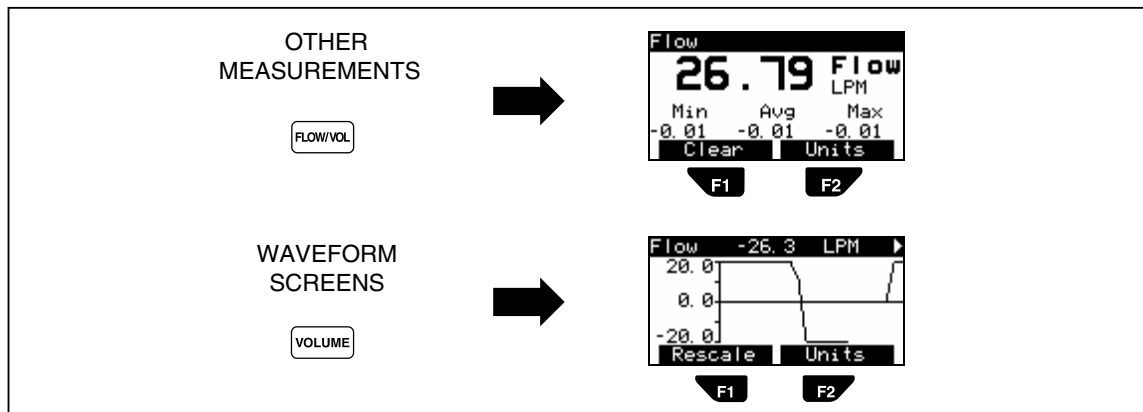

Figure 6-4. Accessing High-Flow Measurements

edg25f.eps

## Measuring Volume

The Analyzer integrates (sums) the high- or low-flow signal over a period of time to obtain volume. The Analyzer measures volume in units of Liters, CF (cubic feet), or mL (milliliters). Maximum low-flow volume is  $\pm 60$  l, and maximum high-flow volume is  $> \pm 60$  l. All correction modes and other measurement accuracy considerations applicable to flow measurement apply for volume measurements. To make a volume measurement, follow these steps:

1. Connect the Analyzer for low-flow or high-flow measurement as shown in Figure 6-1 or 6-3, respectively.

2. Press **FLOW/VOL** under OTHER MEASUREMENTS until the volume screen shown below appears.

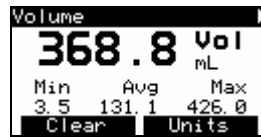

ede38s.bmp

*Note*

*Tidal Volume and Minute Volume calculated parameters are also available by pressing **FLOW/VOL** under VENTILATOR PARAMETERS.*

# **Chapter 7**

## **Maintaining and Troubleshooting the VT MOBILE**

### **Introduction**

This chapter provides enough information to help you troubleshoot possible Analyzer failures and perform diagnostics.

Leave service of the Analyzer to qualified Service personnel. Leave calibration of the Analyzer to qualified Fluke Biomedical Service personnel to ensure that the Analyzer remains under warranty.

### **Calibration and Service**

Have a qualified technician calibrate the Analyzer once a year. We recommend that you send the Analyzer to a Fluke service center for calibration or service.

### **Battery**

The Analyzer uses a 9-volt, non-rechargeable alkaline battery. Refer to Figure 7-1 for battery replacement instructions.

If battery voltage drops too low, the message “Warning Your Battery Is Low” appears on the screen. Press **F2** (Ok) to resume viewing the previous display. The Analyzer will now occasionally beep and eventually display the warning screen again, allowing you to repeat the process. However, to maintain accurate measurements, replace the battery as soon as possible after the first warning you notice.

Press **MORE** →  → **ENTER** to check the battery level.

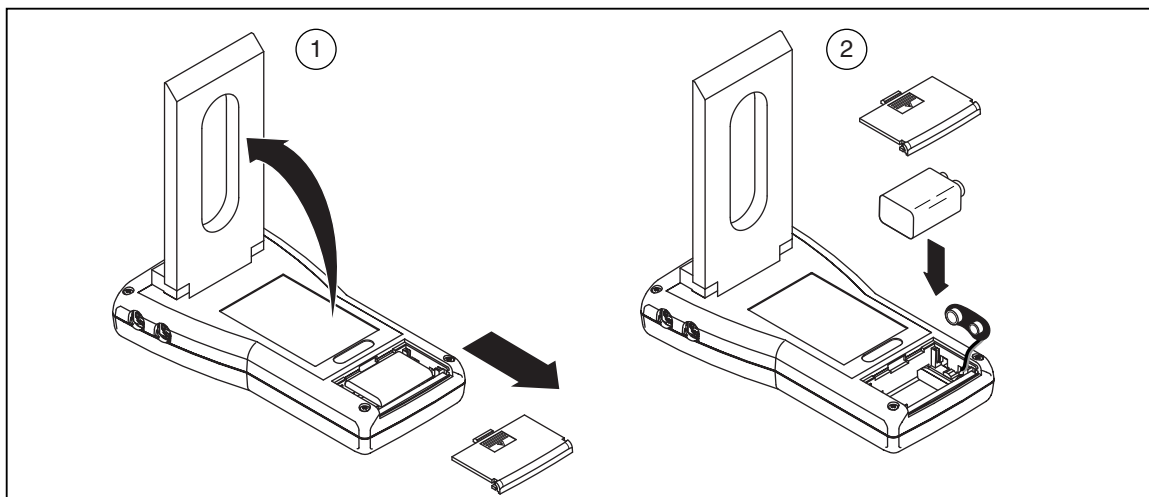

**Figure 7-1. Changing the Battery**

ede09f.eps

## **Cleaning**

Clean the Analyzer with a damp cloth on the exterior only. Use a solution of 70% isopropyl alcohol. Fluke Biomedical does not recommend other solvents.

## **Verifying Oxygen Sensor Calibration**

Verify the oxygen sensor calibration at the beginning of any day during which you expect to measure oxygen concentrations. Use the following verification procedure:

1. Connect the Oxygen Sensor as shown in Figure 7-2.
2. Introduce a 10 lpm or greater flow of 100% oxygen through the Oxygen Sensor "T".
3. Press  $\boxed{\text{RH O}_2}$  to access the O<sub>2</sub> display.
4. Ensure that the O<sub>2</sub> screen oxygen concentration is 100 %  $\pm$  2 % of full scale. If the concentration is less than 98 %, perform the oxygen sensor calibration as described below.
5. Replace the oxygen sensor after one year (or longer if no replacement message appears during calibration.)

### *Note*

*The Oxygen Sensor is not calibrated at the factory.*

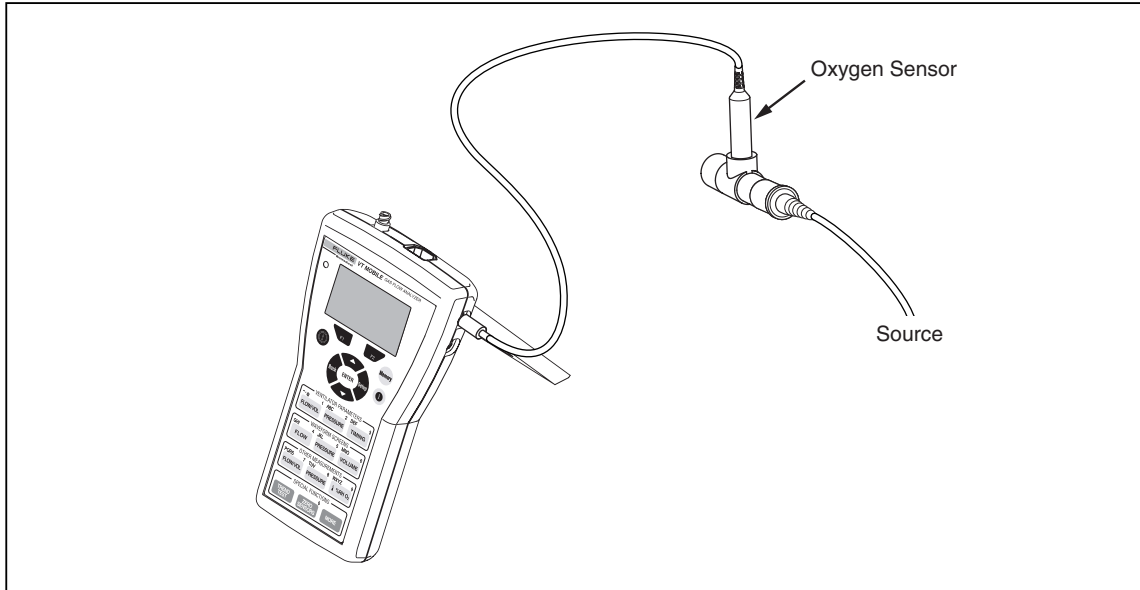

**Figure 7-2. Oxygen Sensor Calibration**

edg20f.eps

## Replacing the Oxygen Sensor

The Analyzer uses a galvanic oxygen sensor warranted for 12 months. Replace the oxygen sensor cell when you cannot successfully complete the oxygen sensor verification. The oxygen sensor may operate for longer than 12 months depending on use. To replace the oxygen sensor, unscrew the cable and pull the sensor cell out of its T connector.

Follow the oxygen sensor manufacturer's unpacking and installation instructions. You may need to expose oxygen sensors to room air for 24 hours prior to installation or calibration.

## Calibrating the Oxygen Sensor

Calibrating the Oxygen Sensor improves pressure compensation for barometric and airway pressure changes.

1. Press **F1** to display the Oxygen measurement screen.
2. Press **F2** to access the Oxygen calibration screen.
3. Connect the High-Flow Sensor and then apply dry air (20.9 % oxygen) at 10 lpm to either side of the sensor.
4. Press **F1** twice to access the Calibration screen. Wait for the two-minute timer to count down.
5. Apply 100 % oxygen at 10 lpm.
6. Press **F2** twice and then press **F1** once to access the Calibration screen.
7. After the two-minute interval, the Oxygen measurement screen appears and the calibration is complete.

## Troubleshooting

Refer to Table 7-1 for troubleshooting procedures.

**Table 7-1. Troubleshooting the Analyzer**

| <b>Problem</b>  | <b>Possible Cause</b>   | <b>Corrective Action</b>   |
|---|---|--|
| Analyzer does not turn on -<br>Screen is dark   | No power or dead battery<br><br>Screen contrast not set   | Plug battery eliminator into an AC<br>mains outlet or install a new battery.<br><br>Press the Power key on.<br><br>Adjust screen contrast.   |
| Analyzer screen turns on but<br>displays nothing. Splash may or<br>may not appear before screen<br>goes blank | Flash program memory not<br>loaded<br><br>Flash memory or boot memory<br>resulted in incorrect checksum.<br><br>Screen contrast not set   | If problem persists, call Service.<br><br>If problem persists, call Service.<br><br>Adjust screen contrast   |
| Screen is difficult to read   | Screen contrast not set   | Adjust screen contrast   |
| "Out of Range" messages<br>appear   | Measured signals out of<br>specified range<br><br>Unit calibration is incorrect   | Ensure that all pressures and flow<br>rates are within <i>the</i> Analyzer specified<br>limits.<br><br>If problem persists, call Service.  |
| Tidal Volumes are erratic   | Breath detection threshold set<br>too low. Noise from ventilator is<br>causing "false" breaths.   | Set the breath detection threshold to a<br>higher value.   |
| Tidal volumes different than<br>expected.   | Your expected value was<br>incorrect.<br><br>Flow baseline drifts, causing a<br>false non-zero flow reading<br>when flow was actually zero.<br><br>Analyzer is out of calibration.<br><br>Gas settings are incorrect.<br><br>Correction mode is set to BTPS<br>or STPD instead of ATP.<br><br>BTPS or STPD correction<br>method on the Analyzer is<br>different that the method used<br>by the ventilator manufacturer. | Review expectations.<br><br>Zero the flow reading.<br><br>Contact Service.<br><br>Review Analyzer gas settings.<br><br>Set gas mode to appropriate setting for<br>your application. Most applications may<br>require the ATP mode.<br><br>Corrections for BTPS and STPD may<br>vary among different ventilator<br>manufactures. The biggest difference<br>is in the water vapor volume correction.<br>The Analyzer uses the setting for<br>relative humidity and temperature to<br>determine the actual volume of water<br>vapor in the flowing gas. The Analyzer<br>subtracts this volume from the total<br>volume for "dry" gas corrections. For<br>"saturated" gas correction, the<br>Analyzer computes a make-up volume<br>of water vapor and adds it to the<br>measured volume. |



**Table 7-1. Troubleshooting the Analyzer (cont.)**

| Problem  | Possible Cause   | Corrective Action  |
|--|--|--|
|  | <p>Compliance of breathing circuit tubing is causing a compressible volume loss.</p> <p>You are using the Analyzer with humidified gases. Condensation on the flow sensors causes a calibration error on the flow measurement.</p> | <p>Determine the breathing circuit compliance to calculate the expected volume loss due to compressibility of the gas and expansion of the hose.</p> <p>Run dry air through the flow sensor for 10 to 30 minutes to allow the screen mesh to dry.</p> <p>Do not use the Analyzer with condensing humidified gases.</p>   |
| Flow or pressure measurement is not equal to zero when zero flow or pressure is applied. | Baseline drift of pressure transducer  | Zero the affected signal by using  while the affected signal is displayed. For example, you can zero low pressure while the Analyzer displays the low-pressure screen.  |
| Zeroing flow results in unexpected flow readings or an error message.                    | Flow was not zero.   | Ensure that there is no flow when zeroing the flow sensor.   |
| Barometric pressure is incorrect   | Barometric pressure offset drift   | Enter correct barometric pressure.   |
| You observe no flow measurement with flow applied.                                       | Wrong flow sensor is connected   | Connect the right flow sensor. See Specifications.   |
| No observable airway pressure.   | Wrong flow sensor connected.   | Connect the right flow sensor.   |
| Ventilator parameters seem incorrect.  | Analyzer in circuit backwards  | Ensure the inlet is near to the Y piece.   |
| Analyzer takes a long time to establish communications with PC software.                 | This is normal.  | <p>If the Analyzer does not eventually communicate with the PC software, ensure the cable is correctly connected and that the PC hardware can support the communication port selected.</p> <p>Make sure no other device is trying to use the serial port on your PC. Close any software that may be using the serial port. Make sure that Windows® recognizes the serial port in the Control Panel. Restart the VT for Windows software.</p> |



# **Appendix A**

## **VT for Windows**

### **Getting Started**

#### **System Requirements**

VT for Windows requires the following system capabilities:

- Microsoft® Windows®
- 256 MB of RAM required
- 1 GHz Pentium III system required

On slower computers, the VT for Windows software may not be able to display the real-time waveform data. If you are using a slower computer than recommended and a problem occurs, select Parameters from the Communications menu.

#### **Connecting to the Analyzer**

The Analyzer uses a special 9-pin serial cable to connect to a PC. Plug the serial cable into the miniature RS232 port on the left side of the Analyzer and into an unused serial (com) port on your PC.

As it launches, the VT for Windows software automatically places the Analyzer into the computer control mode. No graphics appear on the Analyzer screen during serial communications; the Analyzer displays:

`"No Graphics Available, While Communications Are Active."`

#### **Installing the Software**

Place the VT for Windows CD into the CD drive on your PC. If VT for Windows does not initiate installation automatically, select Run from the Start menu, and type in "(CD drive designator):\setup.exe." Then click OK.

The installation program for VT for Windows asks you several questions before installing the program. You can specify where you want the program installed on your computer. If you are installing over a previous version of this software, you must provide a location for backing up old copies of your files. In addition, you must specify where to put the icons for the VT for Windows program. Follow the instructions given by the installation program. If there are no changes to the default installation options, VT for Windows installs to "C:\Program Files\VTPlus."

### **Starting the Software**

With the software installed and the Analyzer connected, you are ready to start the software application. Upon first use, the application attempts to establish communications with the Analyzer.

The software checks the serial communication ports (also called Comm Ports) listed in the Windows Registry. If the software cannot find the Analyzer, the screen in Figure A-1 appears, allowing you to set the communication port used for connecting the Analyzer.

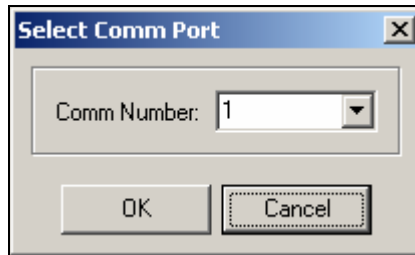

edg53s.bmp

**Figure A-1. Comm Port Selection**

Once the software has established communication with the Analyzer, it creates an initialization file to read during future use. The software uses the information in the initialization file to know where to check for the Analyzer.

An error can occur if the communication port is in use by another device and/or software application. To solve this error, close the application that is using the required communication port.

Finally, if you need to manually set or change the communication port for the Analyzer, start VT for Windows and select Communications → Comm Port from the pull-down menu. Select the appropriate communication port. You can tell that VT Mobile has established communications when it starts displaying waveforms and changing values for flow and pressure.

## Using VT for Windows

VT for Windows provides a simple interface for recording and playing back data calculated by the Analyzer. Refer to Figure A-2 and Table A-1. Most functions on the Analyzer are available using VT for Windows. The Full Test screen presents all ventilator parameters in one place.

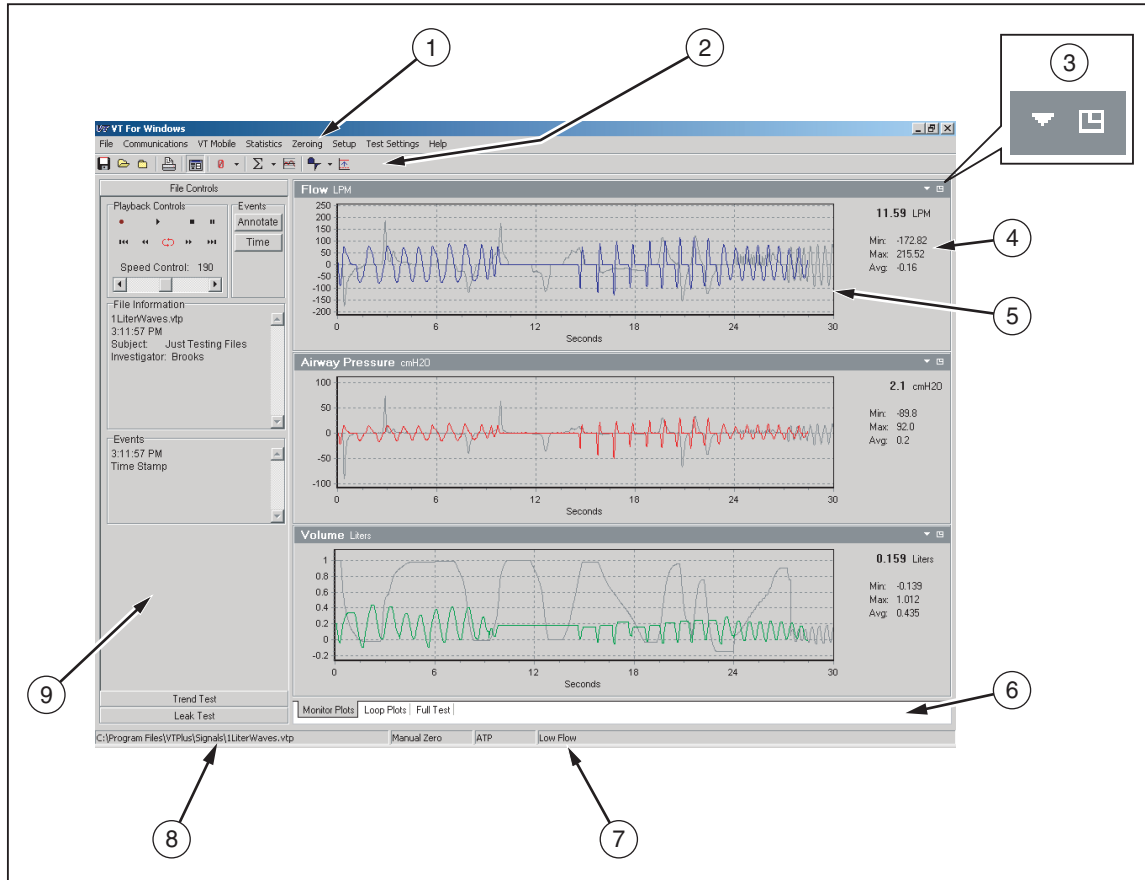



Figure A-2. Screen Elements

edg70f.eps

**Table A-1. Screen Elements**

| Number | Name                            | Description  |
|--------|---------------------------------|--|
| ①      | Menu                            | Access most functions through the menu.  |
| ②      | Toolbar                         | Buttons on the toolbar access commonly used menu functions.  |
| ③      | Plot Icons                      | Use  to access the Plot menu.<br>Use  to toggle between the Monitor Plots and Single Plot screens.   |
| ④      | Statistics Area                 | This area shows the present reading, along with updating statistics for minimum, maximum, and average of the signals encountered.  |
| ⑤      | Plot Area                       | The plot area shows the present (or present and previous) waveform along a selectable time interval.   |
| ⑥      | Screen Tabs                     | The VT for Windows software provides several review and test screens, accessible through the tab set near the bottom of the screen. These screens are the Monitor screen, the Single Plot screen, the Loop Plots screen, and the Full Test screen. In addition, the Test Settings menu allows access to the Trend Test, Leak Test, and Stacked Test screens. |
| ⑦      | Status Bar                      | A status bar (6) appears at the bottom of the screen; this shows the current status of several user settings, including zeroing mode, correction mode, and the selected flow port. System messages such as Zeroing also appear here.   |
| ⑧      | Selected File \ System Messages | This area shows the path to any displayed and stored signal.   |
| ⑨      | File Controls and Test Settings | Panels appear here for File Controls, Trend Test, and Leak Test functions.   |

### Using the Menu Bar

VT for Windows provides you with a menu for easy access to the program's functions. A brief description of the software's menu structure follows. Refer to Figure A-3.

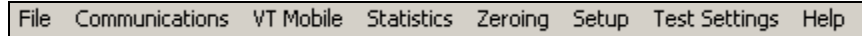

edg55s.bmp

**Figure A-3. Menu Bar**

### File

This selection allows you to save, open, print, and close files, along with other functions. Refer to Figure A-4. Refer to additional file information later in this Appendix.

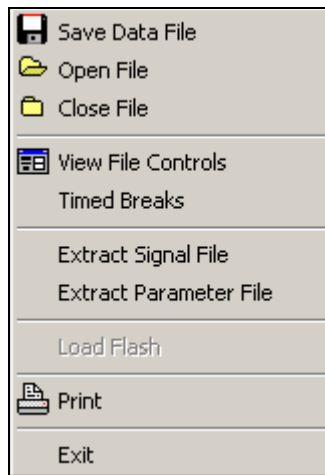

edg82s.bmp

**Figure A-4. File Menu**

### Communications

The Communications menu (Figure A-5) allows you to select the communications port and the serial data mode. For a complete description, see the Serial Communications section in this appendix.

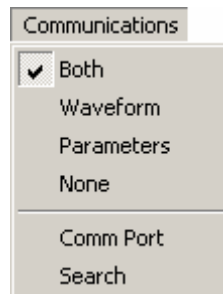

edg83s.bmp

**Figure A-5. Communications Menu**

### VT Mobile

This selection allows you to download files from the Analyzer.

### Statistics

The Statistics menu gives access to the clear function for any or all statistics. The Clear Statistics function clears the statistics for all the signals and the breath parameters at once. Clear individual signal statistics by selecting the appropriate option. Refer to Figure A-6.

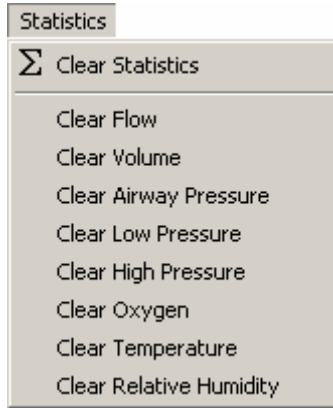

edg84s.bmp

**Figure A-6. Statistics Menu**

### Zeroing

The Zeroing menu (Figure A-7) allows you to zero all of the signals manually. The Zero All function zeros all the signals except oxygen. The Oxygen function allows you to zero sensor drift at 21% oxygen and calibrate at 100% oxygen.

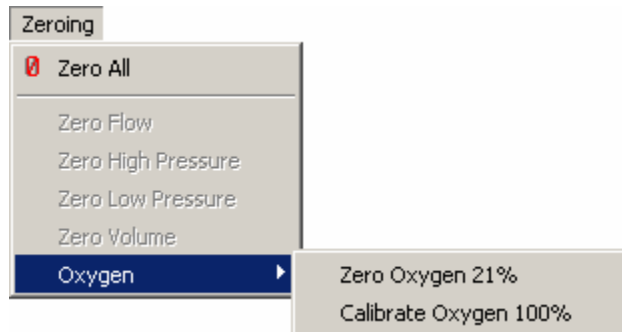

edg85s.bmp

**Figure A-7. Zeroing Menu**

### Setup

The Setup menu (Figure A-8) provides access to some of the user setup features found in the Analyzer, including:

- **Breath Detect:**  
Use the Breath Detect menu to switch breath detection modes and set the breath detect threshold for the current flow port.
- **Gas Settings:**



The Gas Settings function brings up the Gas Settings dialog box. See the Gas Settings section later in this appendix.

- **Gas Calculator:**  
 This function brings up the Gas Calculator dialog box, where you can enter gas percentages, temperature, and relative humidity.
- **Barometric Pressure:**  
 This function brings up the Barometric Pressure dialog box. Enter the local barometric pressure in mmHg and click OK to calibrate the barometric pressure sensor.
- **Units:**  
 The Units function brings up a dialog box for entering the desired units for the signals.
- **Printout Header:**  
 The Printout Header function sets the print header in the Analyzer. See the Printing section in this appendix.

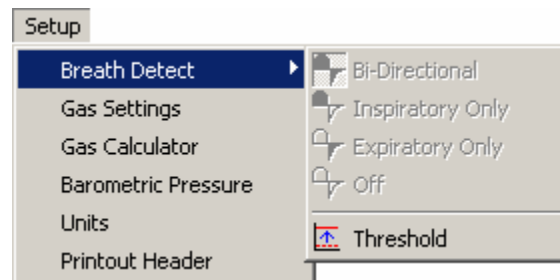

Figure A-8. Setup Menu

edg86s.bmp

### Test Settings

The Test Settings selection allows you to initiate a Leak or Trend test and adjust settings for the Stacked test. You can also specify whether the previous monitor plot remains on the display while VT for Windows displays a new plot. Finally, you can change the time scale of all monitor plots. Refer to Figure A-9.

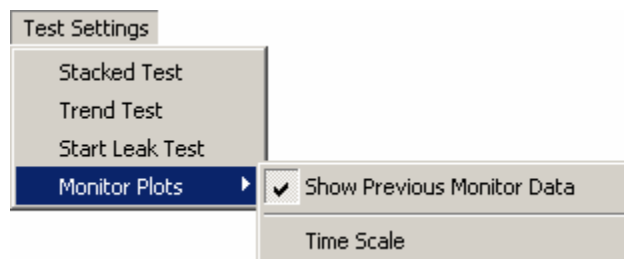

Figure A-9. Test Settings Menu

edg87s.bmp

### Help

The Help menu accesses the VT for Windows About window.

### Using the Toolbar











The toolbar (Figure A-10) provides both convenience and speed. It provides a quick and easy way to call often-used functions. Table A-2 presents descriptions of the buttons and their functions.



**Figure A-10. Toolbar**

edg56s.bmp

**Table A-2. Toolbar Buttons**



| Button  | Name                            | Description  |
|---|---------------------------------|--|
|    | Save As button                  | This button calls up the Save As dialog and allows you to begin saving your data to a file.  |
|    | Open file button                | This button calls the Open dialog that allows you to begin reviewing a file.   |
|    | Close file button               | This button closes any open data files.  |
|    | Print button                    | This button gives you quick access to the print functions. Click this button to open the Print dialog box.   |
|   | File controls button            | This button toggles the File Controls window on or off.  |
|  | Zeroing button                  | This button forces the Analyzer to zero immediately. For more information about zeroing choices with the pull-down menu, see the Zeroing section.  |
|  | Clear Statistics button         | This button forces the Analyzer to clear either a selected statistic or all statistics.  |
|  | Re-scale button                 | This button forces all the plots to re-scale immediately, rather than wait for the auto scale to re-scale them. Note that the Re-scale button only rescales plots that are set to Auto Rescale and does not affect a plot that is set to manually scale. |
|  | (not used)                      | The Analyzer uses the bi-directional breath detect mode.   |
|  | Breath Detection Flow Threshold | This button brings up a dialog box for entering the breath detection flow threshold. For more information, see the Other Setup Functions section.  |

### Using the Main Screens

You can access four main screens with VT for Windows. Switch among Monitor Plots, Loop Plots, and Full Test screens by selecting the appropriate file tab on the bottom of the screen. Select the Single Plot screen by clicking the Plot icon from the Monitor Plots screen.

### Monitor Plots Screen

The Monitor screen (Figure A-11) allows you to observe three of the signals at the same time. Configure each plot to display any of the signals (flow, volume, airway pressure, low pressure, high pressure, oxygen, temperature, or relative humidity). You can set each plot independently to auto-scaling or to manually re-scaling to your specified range of

values. The statistics for the selected signals (min, max, average, and current value) appear on the right side of the screen. In the upper right corner of each plot, you can select the  icon to access the Plot menu or the  icon to toggle between the Monitor Plots and Single Plot screens.

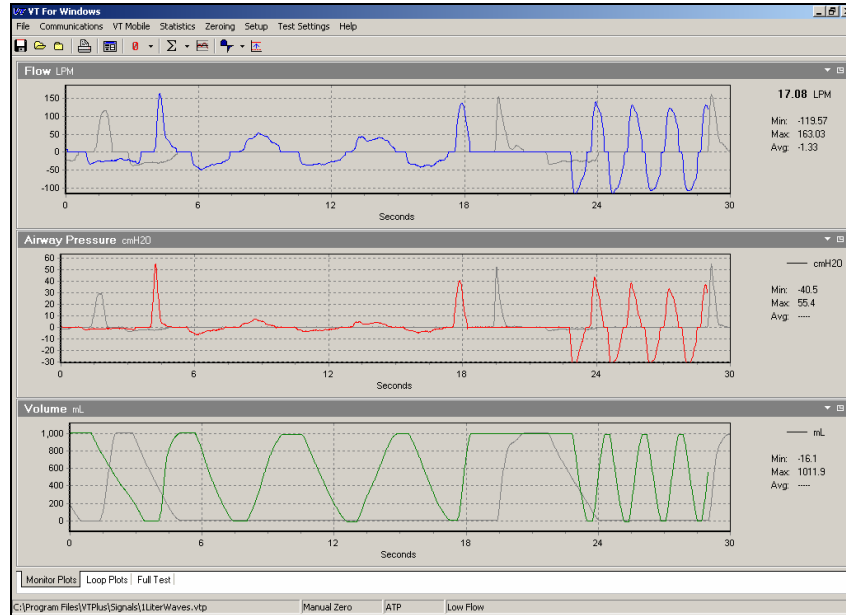

Figure A-11. Monitor Screen

edg57s.bmp

### Single Plot Screen

Toggle between three-signal and one-signal view by clicking the small screen icon in the upper right corner of the plot. Figure A-12 shows a Single Plot screen.

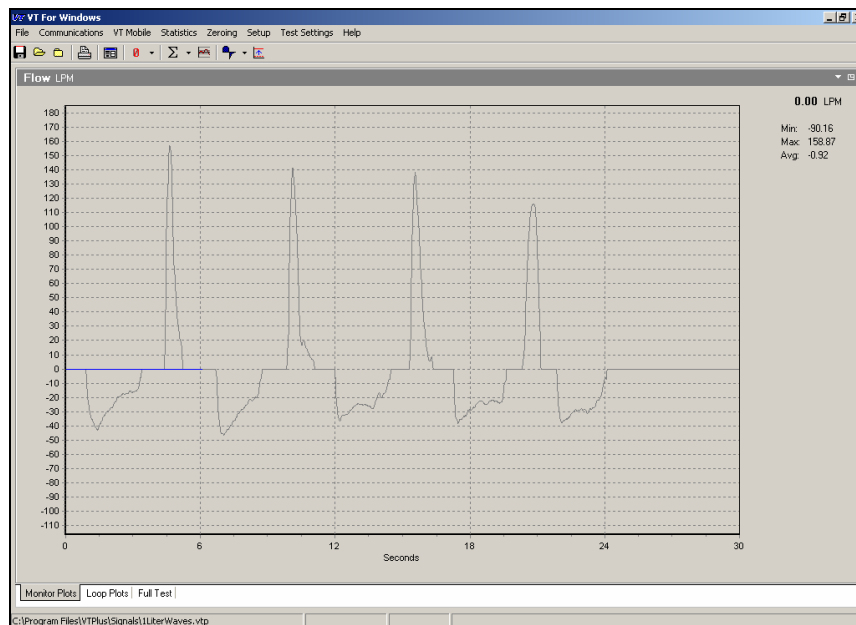

Figure A-12. Single Plot Screen

edg58s.bmp

### Loop Plots Screen

This screen shows plots of Flow vs. Volume and Volume vs. Airway Pressure. You can independently rescale these plots either automatically or manually. Refer to Figure A-13.

Use controls accessible from the pull-down menu in the upper right corner of each plot as follows:

- Rescale: select the Rescale submenu. The Auto Re-scale selection returns the plot to auto rescaling mode, where the plots rescale automatically based on the minimum and maximum signals. The Manual Scale selection allows you to select the scales on which the plots will be shown and disable Auto Re-scale for that plot.
- Clear: erase the present plot and start over.

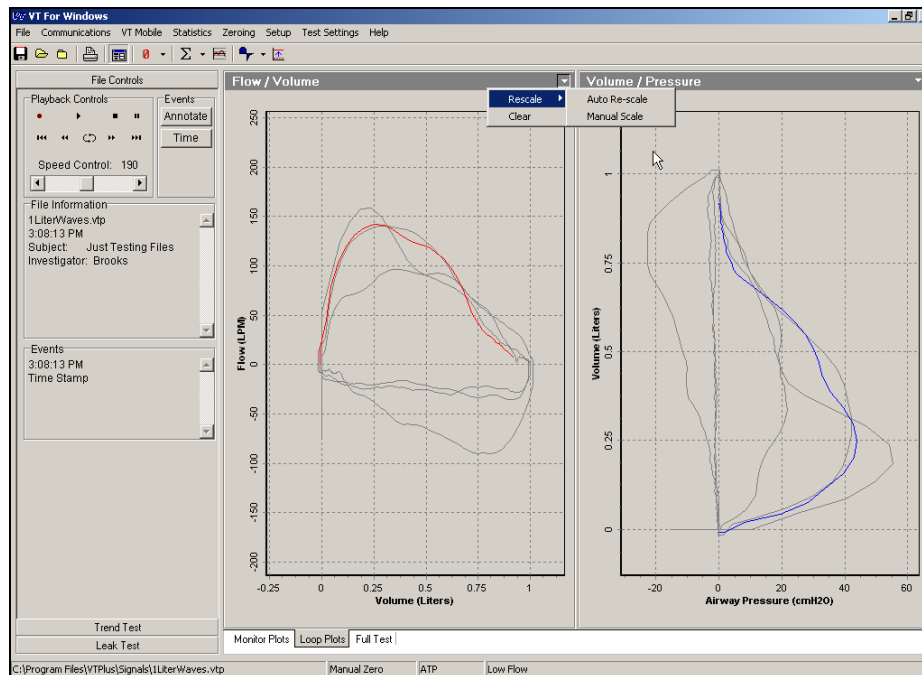

Figure A-13. Looped Plots Screen

edg59s.bmp

## Full Test Screen

The Full Test screen (Figure A-14) displays the calculated parameters for the last breath. These parameters update only when a new breath occurs. A "\*\*\*\*\*" value means that value is invalid or the software could not calculate the value. Depending on your breath-detect mode, some parameters may not be calculable.

| Detailed View   |  |
|---|--|
| Tidal Volume: 998.5 mL      Avg: 1003.2    Min: 991.4    Max: 1011.9  |  |
| <input type="button" value="Trend Test"/> <input type="button" value="Stacked Test"/> Stacked Value: 5026.4 (5) |  |
| Flow & Volume   | Timing   |
| <input checked="" type="checkbox"/> Tidal Volume: 998.5 mL  | <input type="checkbox"/> Inspiratory Time: 2.40 sec      |
| <input type="checkbox"/> Minute Volume: 12.856 LPM  | <input type="checkbox"/> Expiratory Time: 2.20 sec       |
| <input type="checkbox"/> Peak Inspiratory Flow: 42.15 LPM   | <input type="checkbox"/> Inspiratory Hold Time: 0.50 sec |
| <input type="checkbox"/> Peak Expiratory Flow: 43.50 LPM  | <input type="checkbox"/> Expiratory Hold Time: 0.30 sec  |
| <input type="checkbox"/> Base Flow: ----- LPM   | I:E Ratio: 1.09:1  |
| Pressure  | <input type="checkbox"/> Respiratory Rate: 13.0 BPM      |
| <input type="checkbox"/> Mean Airway Pressure: 0.0 cmH2O  | Other  |
| <input type="checkbox"/> Peak Inspiratory Pressure: 5.0 cmH2O   | <input type="checkbox"/> Compliance: ----- ml/cmH2O      |
| <input type="checkbox"/> Inspiratory Pause Pressure: 0.0 cmH2O  | <input type="checkbox"/> O2 Percent: 19.9 %              |
| <input type="checkbox"/> PEEP: 0.0 cmH2O  | <input type="checkbox"/> Temperature: 28.1 deg C         |
| <input type="checkbox"/> Min. Airway Pressure: ----- cmH2O  | <input type="checkbox"/> Relative Humidity: 33.6 %       |
| <input type="checkbox"/> Assist Pressure: ----- cmH2O   | Barometric Pressure: 663 mmHg                            |

Figure A-14. Full Test Screen

edg60s.bmp

## Conducting a Trend Test

### Overview

The Trend test monitors a single-breath parameter over an extended period. Each time a breath occurs, the software compares the chosen breath parameter to an initial value. If it exceeds the percent limit given for the test, a reported incident occurs. Following the test, you can print a report detailing all the incidents that occurred during the test.

### Starting a Trend Test

Initiate a Trend test by selecting Trend Test from either the Test Settings menu or the Full Test screen. The Trend Test setup dialog box opens, allowing you to choose the parameter on which to run the test, the percent limit for the test, and minimum and maximum limits for the test. Click the OK button to start the test. See Figure A-15.

### Running a Trend Test

During a Trend test, you see several values every time a breath occurs. Refer to Figure A-16.

- **Test Parameter**  
This is the parameter chosen for running this test. This value does not change during the test.
- **Initial Value**  
This is the initial value for the test parameter. This value does not change during the test.
- **Current Value**  
This is the current value of the chosen test parameter. Every time a breath occurs, the software updates and compares the current value against the initial value of the test parameter.

- **Minimum Limit**  
This is the minimum value; a reading below this value results in an incident.
- **Maximum Limit**  
This is the maximum value; a reading above this value results in an incident.
- **Percent Difference**  
The software calculates this value each time a breath occurs. If it is greater than the Percent Limit, a reported incident occurs.
- **Test Number**  
This number increments with each detected breath.
- **Number Of Incidents**  
The number of incidents is incremented each time the percent difference exceeds the percent limit or the current value falls outside the maximum or minimum limit.
- **Elapsed Time**  
This value updates continuously. It keeps track of the run time of the current Trend test.

**Ending a Trend Test**

End the Trend test at any time by clicking the End Trend Test button.

When the Trend test stops, the software reports the final values. Clicking the Print button prints out a copy of the results and the incident reports for the test.

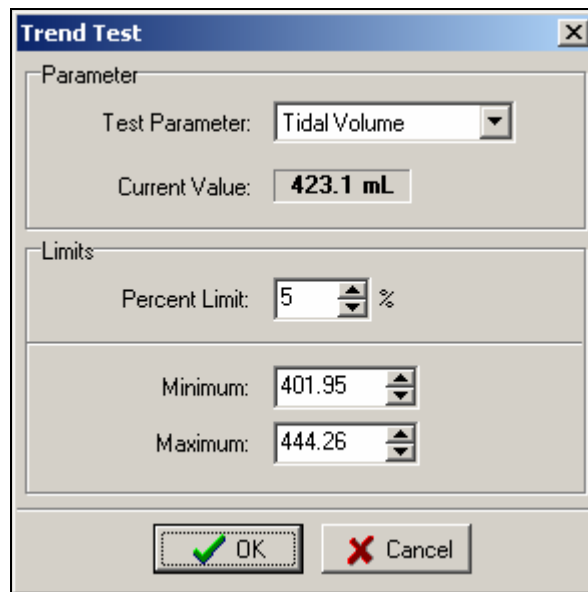

**Figure A-15. Trend Test Window**

edg61s.bmp

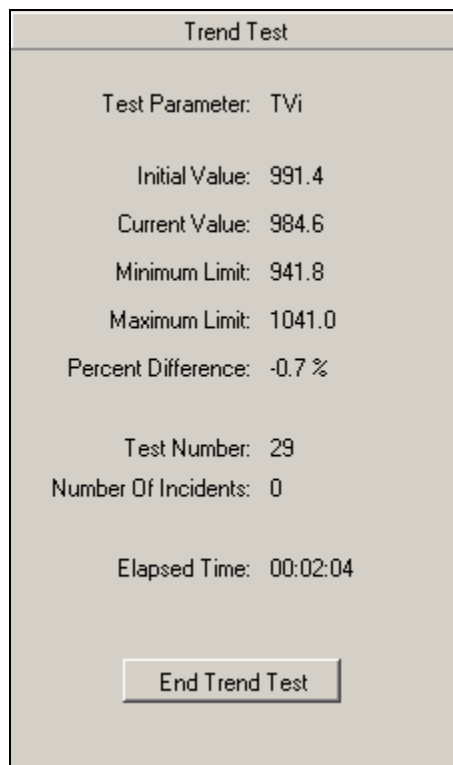

Figure A-16. Trend Test Panel

edg62s.bmp

## Conducting a Leak Test

### Overview

The Leak test is for measuring the leak rate of a sealed vessel or test lung over a period of time.

### Starting a Leak Test

Start the Leak test by selecting the Leak Test tab (accessed by selecting File → View File Controls). Then select Start Leak Test. (You can also start a Leak test by selecting Leak Test from a pressure Plot menu on the Monitor Plots or Single Plot screen.) The dialog box shown in Figure A-17 now appears, giving you the chance to choose the pressure channel on which you want to run the test. In addition, you can change the displayed pressure units. If you choose to enter a compliance value for the system under test, the software calculates the volume lost during the test. Enter the test time to set the length of time that the Leak test runs. The Leak test automatically stops at the end of that amount of time. Click the OK button to begin the Leak test.

### Running a Leak Test

The Leak test plots the chosen pressure channel (airway, low, or high pressure) over the chosen length of time. The Leak test also displays several values calculated during the test. Refer to Figure A-18.

- Current Pressure  
This is the pressure currently measured.
- Initial Pressure

This is the pressure read on the selected pressure channel when the Leak test starts. The initial value does not change during a Leak test.

- **Leak Rate**  
Pressure is being lost at this rate.
- **Elapsed Time**  
This shows the amount of time that the Leak test has been running.
- **Compliance**  
This is the compliance value entered when starting the Leak test. This value does not change during a Leak test.
- **Volume Lost**  
If you entered a compliance value at the start of the Leak test, this value is the amount of volume lost during the Leak test.

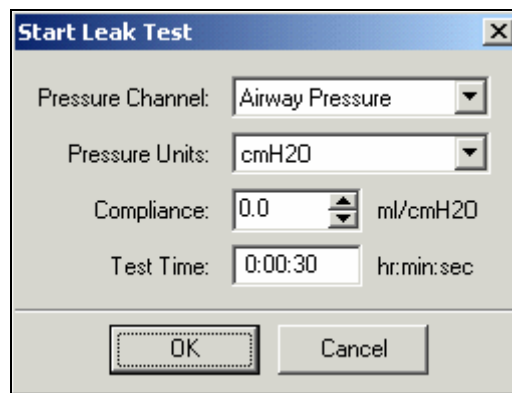

**Figure A-17. Leak Test Dialog Box**

edg63s.bmp



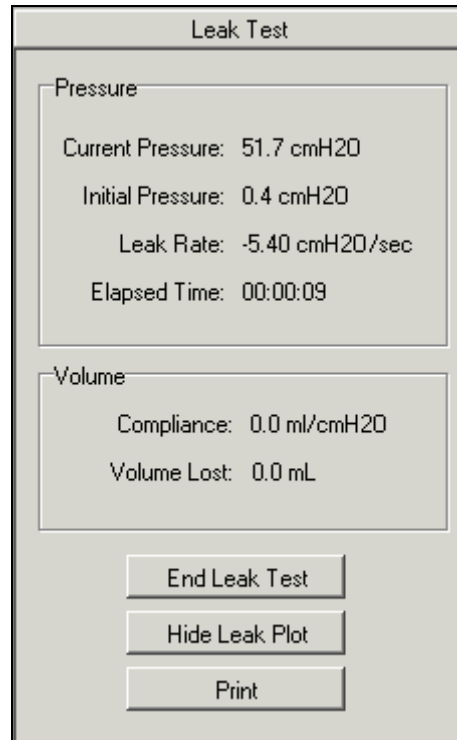

**Figure A-18. Leak Test Panel**

edg88s.bmp

### **Ending a Leak Test**

The Leak test ends when the time runs out or when you terminate it by clicking the End Leak Test button.

When the Leak test is over, VT for Windows prepares a report showing the final values for the calculated parameters. Clicking the Print button prints out a final report for the Leak test.

### **Conducting a Stacked Test**

#### **Overview**

The Stacked test measures breath parameters over a given number of breaths and calculates the average. Select a breath parameter by clicking the square next to the breath parameter's name on the Full Test screen.

#### **Starting a Stacked Test**

VT for Windows runs Stacked tests for all parameters continuously.

Change the number of breaths by selecting Stacked Test in the Test Settings menu or by clicking the Stacked Test button in the Full Test screen. With either access method, the dialog box shown in Figure A-19 now appears. Enter the number of breaths that you want averaged. Click the OK button to resume testing.

#### **Running a Stacked Test**

The Stacked test reports the values shown in Figure A-20. The current value is the breath parameter for the last breath. The Stacked Value reflects the total of the breath parameter calculations for the number of breaths specified.

### **Resetting a Stacked Test**

The test automatically updates the Stacked Value following the number of requested breaths. If you need to restart a Stacked test manually, select Clear Statistics from the Statistics menu.

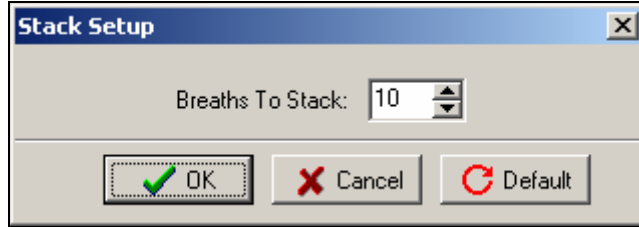

**Figure A-19. Stacked Dialog Box**

edg65s.bmp

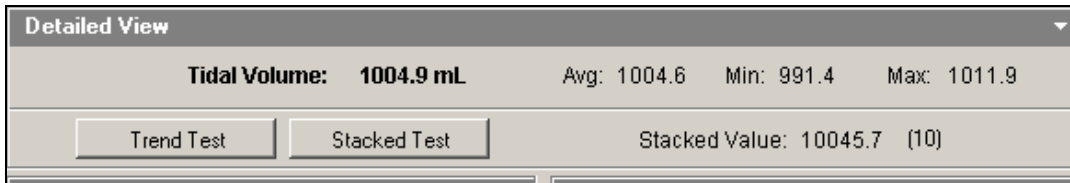
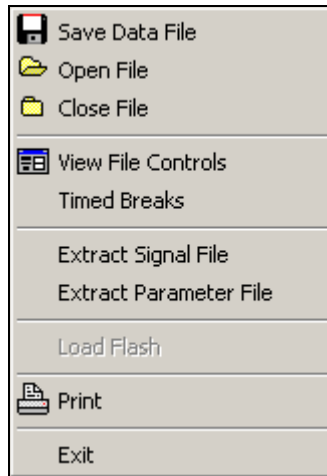

**Figure A-20. Stacked Test Portion of Full Test Screen**

edg89s.bmp

### **Using the File Menu**

The File menu provides the functions shown in Figure A-21 and detailed below.



**Figure A-21. File Menu**

edg67s.bmp

### **Save Data File**

Use this selection to save the open file. You can also use the Save As button on the toolbar. The file may be either a new or an existing file. If it is an existing file, the software prompts you to decide if you want to overwrite the existing file.

*Note*

*VT for Windows does not store data in a buffer (temporary file). If a file is not open and the software is recording, the software saves no data.*

**Open File**

The Open File selection is available to open an existing file for playback. You may also use the Open File button on the toolbar.

**Close File**

To close data files, select Close File from the menu or use the Close File button on the toolbar.

**View File Controls**

The File Controls panel (Figure A-22) is a sub-screen used for recording, annotating, and playing back data files. You can bring up the File Controls panel by selecting the File Controls button on the toolbar or by selecting View File Controls from the File menu.

There are four main sections in the File Controls: Playback Controls, Event Markers, File Information, and Events.

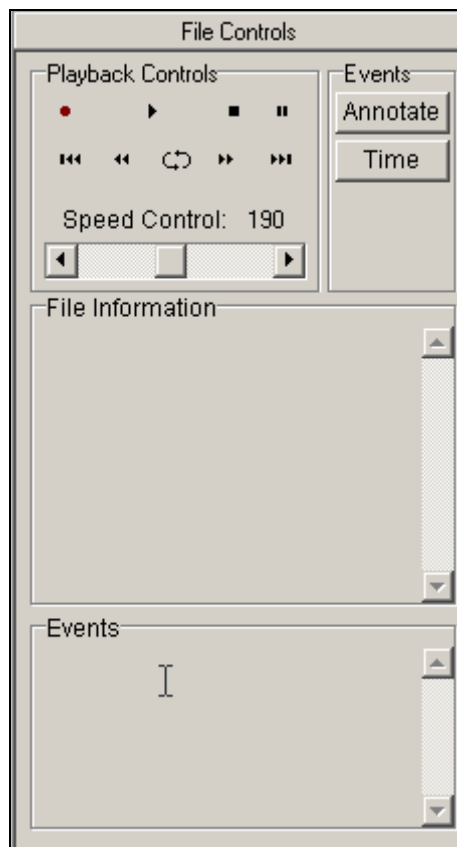











**Figure A-22. File Controls**

edg68s.bmp

**Playback Controls**

Use the controls shown in Table A-3 as aids in data review and recording.



**Table A-3. Playback Controls**

| Button  | Name               | Description   |
|---|--------------------|---|
|    | Record             | The Record button initiates writing data to the open data file. The software places a Time event marker in the data file, indicating the beginning of recording.  |
|    | Play               | The Play button initiates data playback from an open file.  |
|    | Stop               | The Stop button terminates data recording or playback. The software leaves the data file open.  |
|    | Pause              | The Pause button stops data playback temporarily. Pause files before printing so that the software can capture the plot for printing.   |
|    | Start              | This button rewinds the data file to its beginning. This only affects data playback. The software performs all recording at the end of the data file.   |
|    | Rewind             | This button backs up the data file during playback to the previous event marker in the file. Automatic event markers provide periodic events to which you can rewind or forward the file.   |
|  | Continuous Play On | Enable this button during data playback to allow for continuous play. In continuous play, the data file automatically rewinds to the beginning as soon as the end of the file occurs. The button appears red when enabled and black when disabled.  |
|  | Fast Forward       | This button advances the data file during playback to the next event marker in the file. Automatic event markers provide periodic events that enable rewinding or forwarding of the file.   |
|  | End                | This button advances the data file to its end. This only affects data playback.   |
|  | Speed Control      | The speed control adjusts the playback speed. The number shown is the time in milliseconds (ms) between waveform samples. The data sample rate for the Analyzer is 20 ms. Therefore, a number larger than 20 results in slower-than-normal playback; smaller numbers yield a fast playback speed. |

### Manual Event Markers

Event markers assist you during data collection. You can place two events into the file: Annotate and Time. During file recording, these events appear in the Events section of the File Controls panel. See Table A-4.

**Table A-4. Event Markers**

| Button  | Description   |
|---|---|
|  | Pressing this button during recording brings up a dialog box where you may enter notes (text). Upon your pressing OK, the software places your notes and a time stamp in the data file. Note that the time stamp is the time when you pushed the OK button (not the Annotate button).         |
|  | Pressing this button during recording places a time stamp in the data file. A dialog box appears showing the exact time written to the file.<br><br>One use of this function is to correlate data collection in a laboratory notebook or data collection worksheet with the data in the file. |

### Automatic Event Markers

The software places automatic event markers in data files to assist in the Rewind and Forward functions during playback. Rewind and Forward move the data file from event to event. In the absence of user events (i.e. Time or Annotate), there would be beginning and end of file events.

To set the time interval, select Timed Breaks from the File menu. This brings up the dialog box shown in Figure A-23.

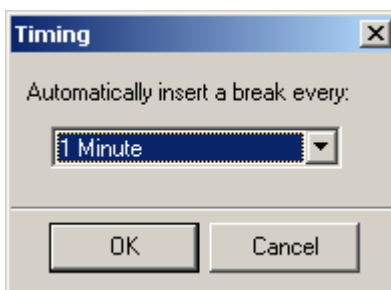

**Figure A-23. Timed Events Dialog Box**

edg90s.bmp

Use this setting to determine how often to place an automatic event marker in the data file. Use event markers with the Forward and Reverse functions of the file playback.

Using the pull-down menu, select the desired time interval between automatic event markers and then select OK. Shorter times allow you to see more of your data during playback.

The software keeps a timer for the automatic event marker. If you insert an event by using Time or Annotate, the timer resets. This is to avoid having automatic events too close to user events.

### **File Information**

Figure A-24 shows the File Information section of the File Controls panel.

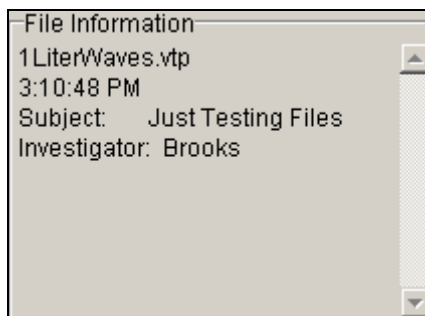

edg71s.bmp

**Figure A-24. File Information Section**

The first line in the information box contains the open file name. The next line is the creation time for the file. The remaining lines contain the information that you provided at file creation.

### **Events**

During file playback, the software checks for event markers in the data files. The Events section of the File Controls panel displays information from the data file regarding the last event played back. VT for Windows displays this information until another event begins.

### **Timed Breaks**

This selection allows you to specify automatically marked intervals in the data file.

### **Extract Signal File**

A signal file is a data file of raw waveforms. The software generates the .sig files from the .vtp files using a file conversion program. Initiate this by selecting Extract Signal File from the File menu. You must close files to enable this option. The .sig files are in ASCII format; you can easily import them into your favorite spreadsheet. They contain raw flow, pressure, volume, auxiliary pressure, and differential pressure time series collected at 20 ms time increments (50 Hz sample rate).

### **Extract Parameter File**

Parameter files store the breath-by-breath calculated ventilator parameters. The software generates the .par files from the .vtp files using a file conversion program. Initiate this by selecting Extract Parameter File from the File menu. You must close files to enable this option. The .par files are in ASCII format; you can easily import them into your favorite spreadsheet.

## Print

You can print reports from the VT for Windows software to any printer installed on your computer.

There are two ways to print from VT for Windows. Selecting Print from the File menu or clicking the Print button on the toolbar brings up the system Print dialog box. This allows you to select which printer you want to use and adjust settings on that printer. Clicking OK sends the report to the printer.

The print header that appears at the top of the reports is stored in the Analyzer. It is loaded into the VT for Windows software every time it connects to an Analyzer unit. Change the print header using the Printout Header function in the Setup menu.

## Using the Plot Menu

Access plot settings by clicking the arrow icon in the upper right corner of the plot. Figure A-25 shows the icon and the resulting Plot menu.

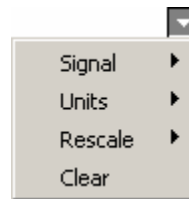

Figure A-25. Plot Menu

edg95s.bmp

## Signal Selection

You can set up the three plots on the Monitor screen and the plot on the Single Plot screen to display any of the signals: flow, volume, airway pressure, low pressure, high pressure, oxygen, temperature, or relative humidity.

To change the displayed signal on a plot, select the plot's name from the Plot menu and select the name of the signal you want displayed. See Figure A-26. The desired signal's name appears on the title of the plot and above the statistics to the right of the plot. The statistics and the plot now reflect the new signal and appear in the selected units for that signal.

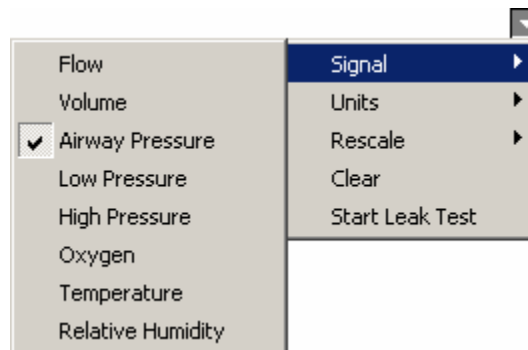
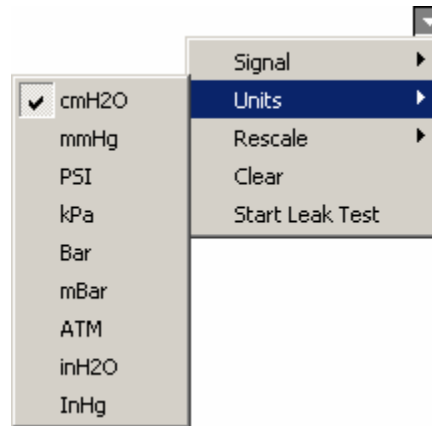

Figure A-26. Selecting a Signal

edg92s.bmp

### Units Selection

To change the units for a signal, select Units from the Plot menu. See Figure A-27. All statistics and plots reflect the current units for the assigned signal.



edg93s.bmp

Figure A-27. Units Window

### Rescaling

This selection allows you to select or deselect auto rescaling, initiate a manual scaling, or adjust the interval over which the signal appears. See Figure A-28.

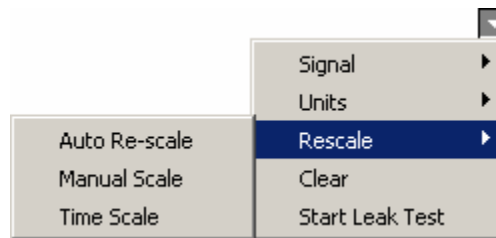

edg94s.bmp

Figure A-28. Plot Rescaling

### Automatically Re-scaling a Plot

By default, the VT for Windows software attempts to re-scale plots so that the entire plot is visible to you. When a re-scale occurs, the software determines the high- and low-ranges on the plots by the min and max statistics for the signal shown on the plot. The monitor plots and the single plot re-scale every time they reach the end of the plot. The software re-scales the loop plots on every breath.

You may turn off the automatic re-scaling for an individual plot by unchecking the box next to the plot's name (Plot → Rescale → Auto Re-scale.) The software automatically turns auto-scaling off for a plot if you manually re-scale that plot.

Clicking the Re-scale button on the toolbar forces an automatic re-scale of all plots to occur immediately.



### Manually Re-scaling a Plot

You can choose a specific range to view on a plot in the following way.

1. Select Rescale and Manual Scale from the Plot menu. The dialog box shown in Figure A-29 appears.

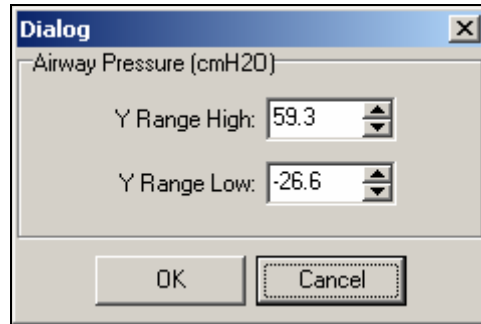

Figure A-29. Manual Rescale

edg91s.bmp

2. Set new Y Range High and Low values with the scroll arrows or by directly entering the values.
3. Click OK.

### Setting the Time Scale

The Time Scale selection allows you to change the interval of the displayed plot signal. Use the scrolling arrows or enter a number directly. Refer to Figure A-30. The minimum allowable time scale is 10 seconds.

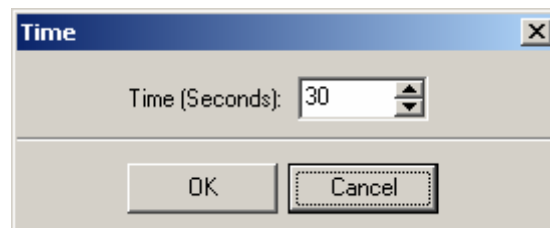

Figure A-30. Time Scale

edg97s.bmp

### Start Leak Test

The Start Leak Test selection is available when you have selected a pressure signal (Airway Pressure, Low Pressure, or High Pressure.)

### Clear

The Clear selection erases existing plots; VT for Windows then begins displaying new plots.

## **Serial Communications**

### **Selecting the COM Port**

The Analyzer communicates with your PC through a serial (COM) port. With the Analyzer connected to your computer and turned on when the software starts, the software automatically detects which COM port the Analyzer is on and then initiates communications between the Analyzer and your PC.

While running VT for Windows you may select Comm Port from the Communications menu to change the port selection.

### **Selecting the Serial Communications Mode**

The Analyzer allows for four modes for data transmission via the serial port. These are available from the Communications menu. The currently selected mode shows a check mark next to its name.

- Both  
This selection starts the automatic transmission of both waveform data and parameter data, as described above.
- Wave Form  
This selection starts the continuous transmission of waveform data from the Analyzer. The software receives flow, volume, airway pressure, auxiliary pressure, and differential pressure data at a 50 Hz rate.
- Parameters  
Start the automatic transmission of parameters calculated at the end of a breath. These parameters update on a breath-to-breath basis. Please note that no parameters update for a breath if a zero occurs during that breath.
- None  
Use this selection to set no data transmission. This stops all automatic data transmissions from the Analyzer.

## **Data and File Handling**

### **File Structure**

VT for Windows files handle three kinds of data: Signals, Parameters, and Events. Signals are the raw flow, pressure, and volume time-series waveforms. Parameters are the breath-by-breath ventilator parameters calculated by the Analyzer device. Events are information placed into the data files by you. VT for Windows provides an interface for you to mark events during data collection.

VT for Windows can generate three different file types:

- \*.vtp  
The software generates .vtp files when you select to save data to a file. These files contain signal, parameters, and event information.
- \*.sig  
Signal file of raw waveforms. The software generates the .sig files from the .vtp files using a file conversion program. Do this by selecting Extract Signal File from the VT for Windows File menu. Close all files to enable this option. The .sig files are in ASCII format; you can easily import them into your favorite spreadsheet.
- \*.par  
Breath-by-breath calculated ventilator parameters. The software generates the .par files from the .vtp files using a file conversion program. Do this by selecting Extract

Parameter File from the VT for Windows File menu. Close all files to enable this option. The .par files are in ASCII format; you can easily import them into your favorite spreadsheet.

VT for Windows uses a simple means to annotate data files. Each of the annotations is marked as an "event" in the data file. When you play data files back, the annotated text and the time of the event appear on the screen.

## Events

VT for Windows supports six different types of events:

1. Start of file
2. Beginning of a recording
3. Time stamp
4. Annotation
5. End of file
6. Automatic event

Each event is marked in the .vtp data file with a time stamp. For the beginning of a recording and for an annotated event, a dialog box appears with a space provided for you to enter the text annotation.

## Zeroing

Periodically, it is a good idea to zero the signals on the Analyzer to null any offset errors in the flow and pressure sensors. You can set the Analyzer to zero flow and airway pressure. This nulls offset errors in the pressure transducers. Do not use this option if there is flow in a flow port. See Figure A-7.

VT for Windows offers two different ways to perform a zero:

1. Select Zero All from the Zeroing menu.

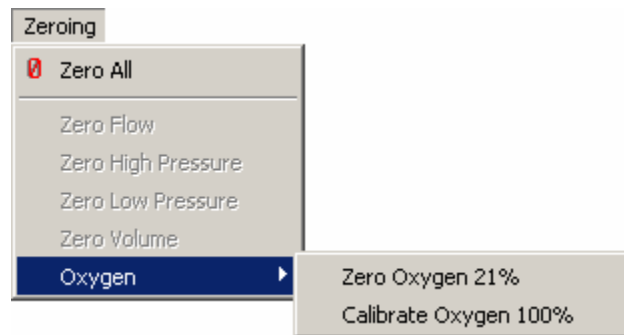

Figure A-31. Zeroing Menu

edg72s.bmp

2. Select Zero All with the Zeroing button on the toolbar.

The Oxygen selection allows you to zero out any offset for drift when air (21% oxygen) passes through one of the flow sensors. You can then calibrate the Oxygen Sensor by applying a flow of 100% oxygen.

## Other Setup Functions

Access these settings from the Setup menu.

### Breath Detect

The Analyzer uses a built-in breath detection algorithm. The algorithm determines the breath phases, rejecting signal noise and other artifacts.

### Breath Detect Threshold

The Analyzer breath detection algorithm uses a flow rate threshold that the flow must cross to trigger a change in the breath phase. Higher flow rate thresholds yield less sensitive breath detection. Lower thresholds yield more sensitive breath detection.

To enter a new threshold, select Threshold from the Breath Detect menu under the Setup menu, as shown in Figure A-32.

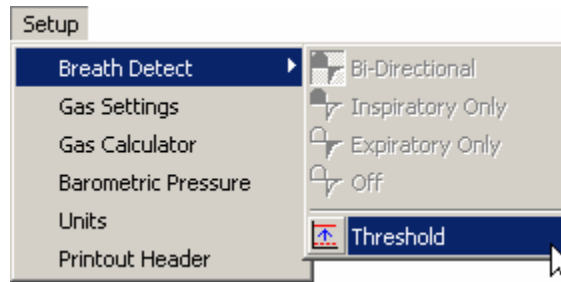

Figure A-32. Breath Detect Threshold Selection

edg96s.bmp

The dialog box shown in Figure A-33 now appears, allowing you to enter your new value. Change the value by using the scrolling arrows or by entering a number directly.

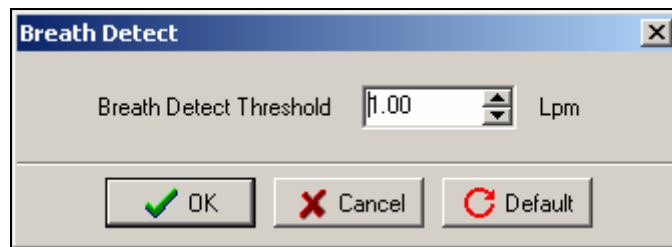

Figure A-33. Breath Detect Dialog Box

edg73s.bmp

## Gas Settings

The Analyzer can compensate for the effects of gas temperature, viscosity, molecular weight, and relative humidity on flow measurement, as well as correct flow calculations to one of several standard conditions. The Gas Settings option gives you access to these settings.

To change the gas settings, select Gas Settings from the Setup menu. The dialog box shown in Figure A-34 appears, allowing you to make the changes.

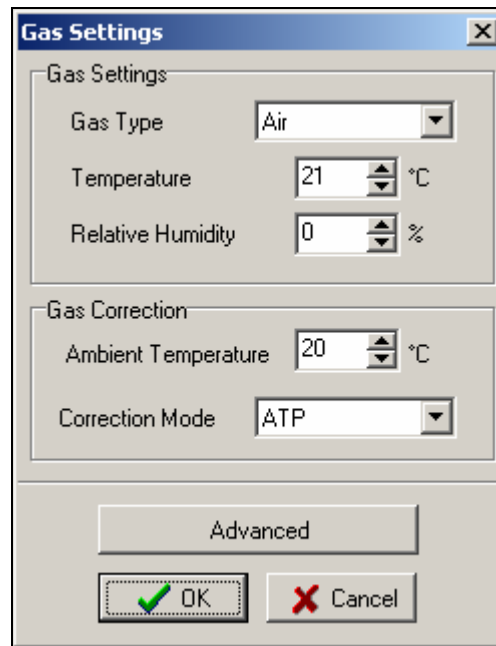

**Figure A-34. Gas Settings Dialog Box**

edg74s.bmp

When you select the Advanced option, the Gas Settings dialog box lets you adjust the temperature, viscosity, molecular weight, and relative humidity for both the inhaled and exhaled gases. In addition, you can adjust the ambient temperature and have the flow adjusted to one of four standard correction modes (ATP, BTPS, STPD0, and STPD21). See Figure A-35.

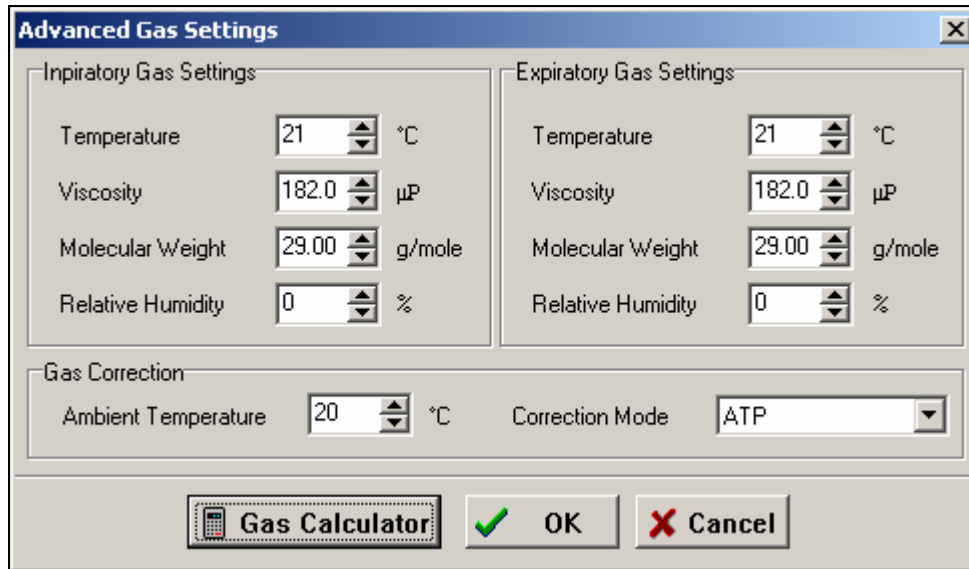

edg75s.bmp

Figure A-35. Advanced Gas Settings Dialog Box

*Note*

*If you do not know the viscosity or molecular weight of the gas you are using, click the Gas Calculator button.*

### **Gas Calculator**

The gas calculator (Figure A-36) allows you to calculate the viscosity and molecular weight of a gas mixture. One gas serves as a balance gas. This means that the calculator automatically adjusts the percentage of this gas to insure that the total percentage of gases totals 100%. To change which gas is the balance gas, click the radio button to the left of the gas's name. Use any of the five standard gases as a balance gas.

You can adjust the percentage each gas makes up of your mixture by changing the values in the two columns to the right of the gas's name. If you have a gas in your mixture that is not one of the standard five, you may use one of the user gases. The user gases have four predefined gas options (halothane, isoflurane, enflurane, and desflurane) and a user-defined option. Select your gas from the list of predefined gases or if the gas you are using is not one of these predefined gases, select the user-defined option. Enter the molecular weight, viscosity coefficient, and viscosity intercept into the boxes given. Clicking the Air button or the Respiration button sets the calculator to the defaults for air or respiration.

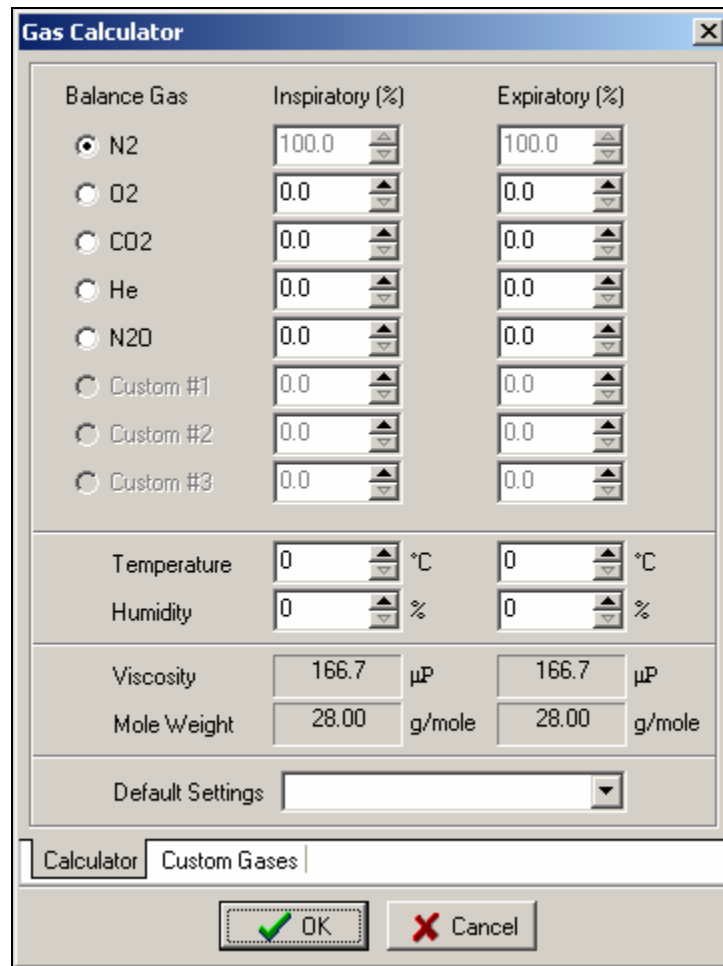

edg77s.bmp

**Figure A-36. Gas Calculator Dialog Box**

Enter the temperature and relative humidity for both inspiratory and expiratory gases in the boxes provided. The software calculates the viscosity and molecular weight every time you make a change to any of the controls. When you are done, click the OK button to accept these values. The software places the viscosity, relative humidity, molecular weight, and temperature in the appropriate boxes in the Gas Settings dialog box.

Click the Custom Gases tab to access the Custom Gases dialog box (Figure A-37). This dialog box allows you to enter gas information specific to user-defined gases.

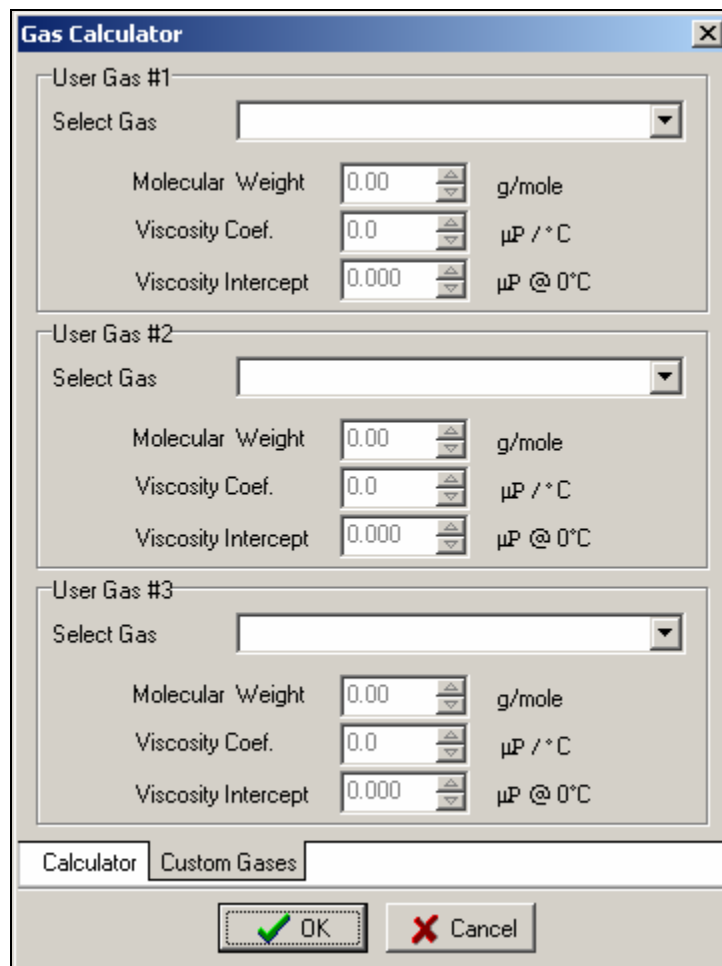

edg76s.bmp

Figure A-37. Custom Gases Window

### Barometric Pressure

The Analyzer automatically calculates the barometric pressure to within 2% of reading. To give greater accuracy, the Analyzer allows you to calibrate the barometric pressure offset by entering the local barometric pressure into the system. The Analyzer uses the entered value to calibrate the system's barometric pressure offset during future use.

#### Note

*Exercise caution in changing barometric pressure readings; correct barometric pressure yields more accurate pressure, flow, and volume readings. Under normal operating conditions, barometric pressure should not need adjustment.*

*The Analyzer relies on ambient barometric pressure. Do not set for airport barometric pressure, which is corrected for altitude.*



To change the barometric pressure, select Barometric Pressure from the Setup menu. Enter the local barometric pressure in the dialog box provided (Figure A-38), and then click the OK button.

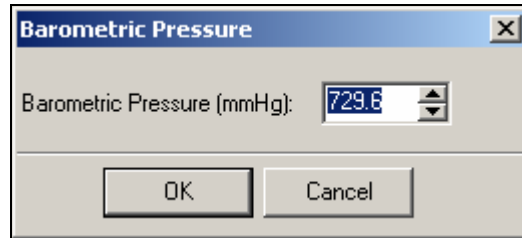

edg78s.bmp

**Figure A-38. Barometric Pressure Dialog Box**

### ***Downloading Files from the Analyzer***

You can download files stored on the Analyzer by selecting VT Mobile → Download Files. Check the required file(s) in the File Download window, and then click the Download button. Finally, select or create a destination folder and click OK. VT for Windows stores downloaded files with the .vtm extension.



# Appendix B

## Specifications

### General Specifications

|                                     |  |
|-------------------------------------|--|
| <b>Size:</b>                        | 8 L x 1.5 H x 4 W inches (20 L x 3.8 H x 10 W cm)  |
| <b>Weight:</b>                      | 1 lb (0.45 kg)   |
| <b>Temperature:</b>                 | Operating: 10 to 40 °C (50 to 104 °F)<br>Storage: -25 to 50 °C (-13 to 122 °F)                               |
| <b>Maximum Humidity, Operating:</b> | 80 % relative humidity up to 31 °C (88 °F), decreasing linearly to 50 % relative humidity at 40 °C (104 °F). |
| <b>Maximum Humidity, Storage:</b>   | 95 %   |
| <b>Barometric:</b>                  | 7 to 18 psia, operating; -1000 to 10000 ft (787.9 – 522.7 mmHg), storage                                     |

### Battery Power Supply

|                           |           |
|---------------------------|-----------|
| <b>Voltage:</b>           | 9 VDC     |
| <b>Power Consumption:</b> | < 70 mA   |
| <b>Battery Life:</b>      | > 7 hours |

### External Power Supply

|                        |           |
|------------------------|-----------|
| <b>Output Voltage:</b> | 12 – 15 V |
| <b>Output Current:</b> | 1.2 A     |

### Measurement Specifications

#### Low-Pressure Port

|   |   |
|---|---|
| <b>Maximum Applied Pressure:</b>          | 5 psi   |
| <b>Operating Pressure (Differential):</b> | -20 to 120 cmH <sub>2</sub> O                                 |
| <b>Operating Pressure (Common Mode):</b>  | NA  |
| <b>Span Accuracy:</b>                     | ± 2 % of reading or 1.5 mmHg, whichever is greater            |
| <b>Frequency Response:</b>                | > 10 Hz   |
| <b>Resolution:</b>                        | 0.1 mmHg  |
| <b>Sample Rate:</b>                       | 100 Hz  |
| <b>Fittings:</b>                          | Flow Connector with 2 tubes "T" connected to a single fitting |

Note: Apply no fluid to the port.

***High-Pressure Port***

|                                  |  |
|----------------------------------|--|
| <b>Maximum Applied Pressure:</b> | 125 psi  |
| <b>Operating Pressure:</b>       | - 2 psi to 100 psi   |
| <b>Span Accuracy:</b>            | $\pm 2\%$ of reading or $\pm 0.2$ psig, whichever is greater |
| <b>Frequency Response:</b>       | > 10 Hz  |
| <b>Resolution:</b>               | 0.1 psi  |
| <b>Sample Rate:</b>              | 100 Hz   |
| <b>Fittings:</b>                 | Single port, Luer lock, stainless steel                      |

Note: Apply no fluid to the port.

***Airway Pressure***

|                                  |  |
|----------------------------------|--|
| <b>Maximum Applied Pressure:</b> | 5 psi  |
| <b>Operating Pressure:</b>       | - 20 cmH <sub>2</sub> O to 120 cmH <sub>2</sub> O                        |
| <b>Span Accuracy:</b>            | $\pm 2\%$ of reading or $\pm 2$ cmH <sub>2</sub> O, whichever is greater |
| <b>Frequency Response:</b>       | > 25 Hz or $t_{10-90} < 40$ ms   |
| <b>Resolution:</b>               | 0.1 cmH <sub>2</sub> O   |
| <b>Sample Rate:</b>              | 100 Hz   |
| <b>Fittings:</b>                 | Internally connected to flow sensor pressure lines                       |

**High-Flow Port**

|  |  |
|--|--|
| <b>Maximum Flow Rate (absolute value):</b> | 200 lpm  |
| <b>Operating Flow Range:</b>               | ± 150 lpm  |
| <b>Accuracy:</b>                           | ± 3 % of reading or ± 2 % of range, whichever is greater |
| <b>Floor for Absolute Accuracy:</b>        | 25 lpm   |
| <b>Resolution:</b>                         | 0.01 lpm   |
| <b>Frequency Response:</b>                 | > 25 Hz or $t_{10-90} < 40$ ms                           |
| <b>Sample Rate:</b>                        | 100 Hz   |
| <b>Dynamic Resistance:</b>                 | < 2 cmH <sub>2</sub> O @ 60 lpm                          |
| <b>Low-Flow Dropout:</b>                   | 2.5 lpm  |
| <b>Breath-Detect Threshold:</b>            | 4 lpm (user selectable)                                  |
| <b>Volume Range:</b>                       | > ± 60 l   |
| <b>Tidal Volume Accuracy:</b>              | ± 3 % of reading or ± 20 ml, whichever is greater        |

**Low-Flow Port**

|  |  |
|--|--|
| <b>Maximum Flow Rate (absolute value):</b> | 35 lpm   |
| <b>Operating Flow Range:</b>               | ± 25 lpm   |
| <b>Accuracy:</b>                           | ± 3 % of reading ± 1% of range, whichever is greater |
| <b>Floor for Absolute Accuracy:</b>        | 3 lpm  |
| <b>Resolution:</b>                         | 0.01 lpm flow > 1 lpm                                |
| <b>Freq. Response:</b>                     | > 25 Hz or $t_{10-90} < 40$ ms                       |
| <b>Sample Rate:</b>                        | 100 Hz   |
| <b>Dynamic Resistance:</b>                 | < 2.5 cmH <sub>2</sub> O @ 5 lpm                     |
| <b>Low-Flow Dropout:</b>                   | 0.24 lpm   |
| <b>Breath-Detect Threshold:</b>            | 1 lpm (user selectable)                              |
| <b>Volume Range:</b>                       | ± 60 l   |
| <b>Tidal Volume Accuracy:</b>              | ± 3 % of reading or ± 5 ml                           |

### **Oxygen Measurement**

|                            |  |
|----------------------------|--|
| <b>Range:</b>              | 0 to 100 %   |
| <b>Accuracy:</b>           | ± 2 % full-scale output                                    |
| <b>Resolution:</b>         | 0.1 % O <sub>2</sub>                                       |
| <b>Frequency Response:</b> | > 15 s (t <sub>10-90</sub> )                               |
| <b>Sample Rate:</b>        | 100 Hz   |
| <b>Sensor Technology:</b>  | Galvanic Fuel Cell   |
| <b>Calibration:</b>        | Allows user calibration using air and 100 % O <sub>2</sub> |

Notes:

- Automatic partial pressure compensation for barometric and airway pressure changes
- Recommended interval for changing the Oxygen Sensor is one year. However, sensor may last longer. During user calibration of the sensor, the Analyzer can detect if the sensor needs replacement.
- Maxtec Oxygen Sensor distributed by Fluke Biomedical

### **Barometric Pressure Measurement**

|                            |  |
|----------------------------|--|
| <b>Range:</b>              | 8 to 18 psia (400 to 900 mmHg)                                   |
| <b>Accuracy:</b>           | ± 2 % of reading   |
| <b>Resolution:</b>         | 0.1 mmHg   |
| <b>Frequency Response:</b> | < 5 s (t <sub>10-90</sub> )                                      |
| <b>Sample Rate:</b>        | N/A  |
| <b>Calibration:</b>        | Not required; however, device allows user calibration of offset. |

### **Temperature and Relative Humidity**

|                    | <b>Temperature</b> | <b>Relative Humidity</b> |
|--------------------|--------------------|--------------------------|
| <b>Resolution:</b> | 0.1 °              | 0.1 %                    |
| <b>Range:</b>      | 0 – 50 °C          | 10 to 95 %               |
| <b>Accuracy:</b>   | ± 1 °C             | ± 10 % RH                |
| <b>Units:</b>      | °C, °F, °K         | %                        |

## Measurement Parameter Specifications

| Parameter                                    | Resolution             | Range                        | Accuracy                      |
|--|------------------------|------------------------------|-------------------------------|
| Inspiratory and Expiratory Tidal Volume (VT) | 0.1 ml                 | > 10 l                       | ± 3 %                         |
| Expiratory Minute Volume (MV)                | 0.001 lpm              | 0 to 60 l                    | ± 3 %                         |
| Breath Rate (BPM)                            | 0.1 bpm                | 2 to 150 bpm                 | ± 1 %                         |
| Inspiratory, Expiratory Time (I:E)           | 0.01 s                 | 0.25 to 9.99 s               | ± 2 % or 0.1 s                |
| Peak Inspiratory Pressure (PIP)              | 0.1 cmH <sub>2</sub> O | ± 120 cmH <sub>2</sub> O     | ± 3 % or 2 cmH <sub>2</sub> O |
| Inspiratory Pause Pressure (IPP)             | 0.1 cmH <sub>2</sub> O | ± 120 cmH <sub>2</sub> O     | ± 3 % or 2 cmH <sub>2</sub> O |
| Mean Airway Pressure (MAP)                   | 0.1 cmH <sub>2</sub> O | ± 80 cmH <sub>2</sub> O      | ± 3 % or 1 cmH <sub>2</sub> O |
| Positive-End Expiratory Pressure (PEEP)      | 0.1 cmH <sub>2</sub> O | - 5 to 40 cmH <sub>2</sub> O | ± 3 % or 1 cmH <sub>2</sub> O |
| Peak Expiratory Flow (PEF)                   | 0.01 lpm               | 0 to 150 lpm                 | ± 3 % or 1 lpm                |
| Peak Inspiratory Flow (PIF)                  | 0.01 lpm               | 0 to 150 lpm                 | ± 3 % or 2 lpm                |
| Inspiratory Time (Ti)                        | 0.01 s                 | 0 to 60 s                    | 0.5 % or 0.02 s               |
| Expiratory Time (Te)                         | 0.01 s                 | 0 to 90 s                    | 0.5 % or 0.01 s               |

### Display Screen

64 x 128 pixels, reflective LCD, blue on yellow

### Operational Modes

Standalone

Controlled by VT for Windows PC Software (version 2.01.00 or higher)

### Gas Types

Air, O<sub>2</sub>, Heliox, CO<sub>2</sub>, N<sub>2</sub>, N<sub>2</sub>O, N<sub>2</sub>O bal O<sub>2</sub>, He bal O<sub>2</sub>, N<sub>2</sub> bal O<sub>2</sub> User

### Serial Communications Specifications

4-pin miniature RS-232 serial port located on upper-left side of the Analyzer

RS232 compatible with the VT for Windows software application (version 2.01.00 or higher.)

